



Electricity Market Opening in South East Europe and Regulatory Developments

Nenad Stefanović

Senior Expert for Electricity

ECRB Electricity Working Group Co-Chairman

**En.Trading 016 - Energy Trading in SEE:
“Going Forward with the Regional Integration!”**

24 May 2016

Hotel Radisson Blu, Belgrade

Installed Generation Capacity in Serbia

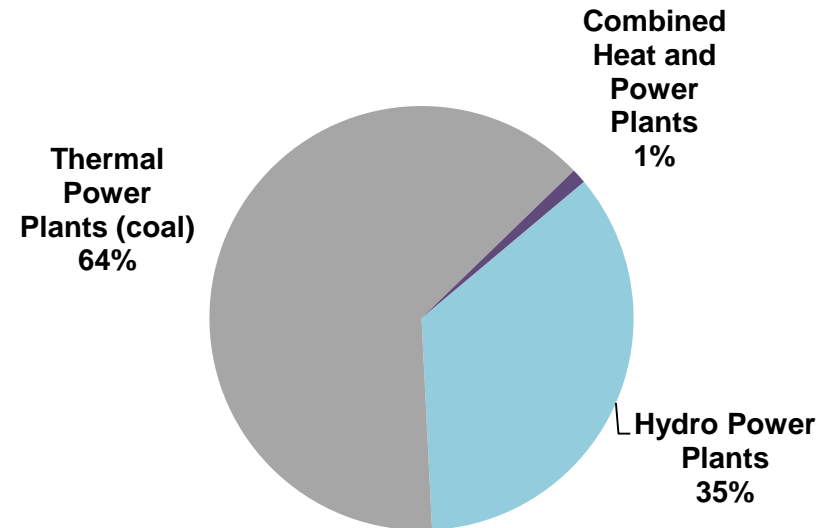
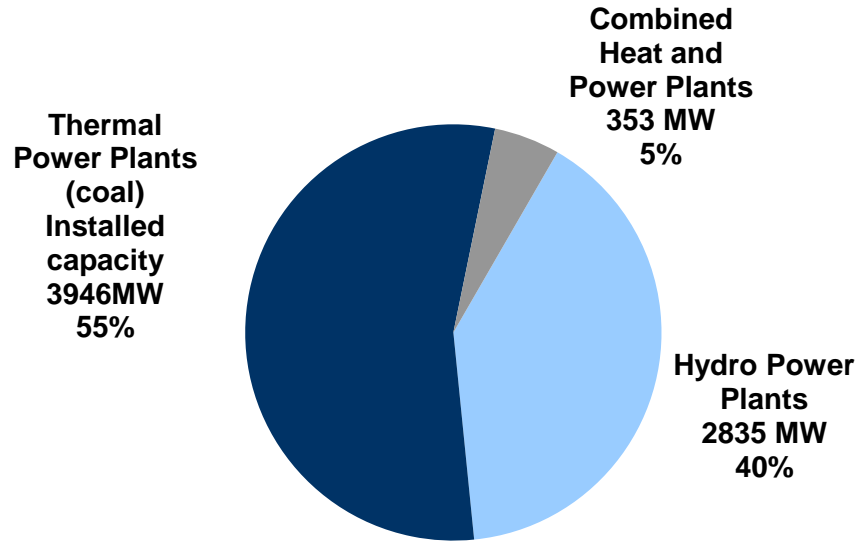

Total Generation in 2015

Transmission Infrastructure in Serbia

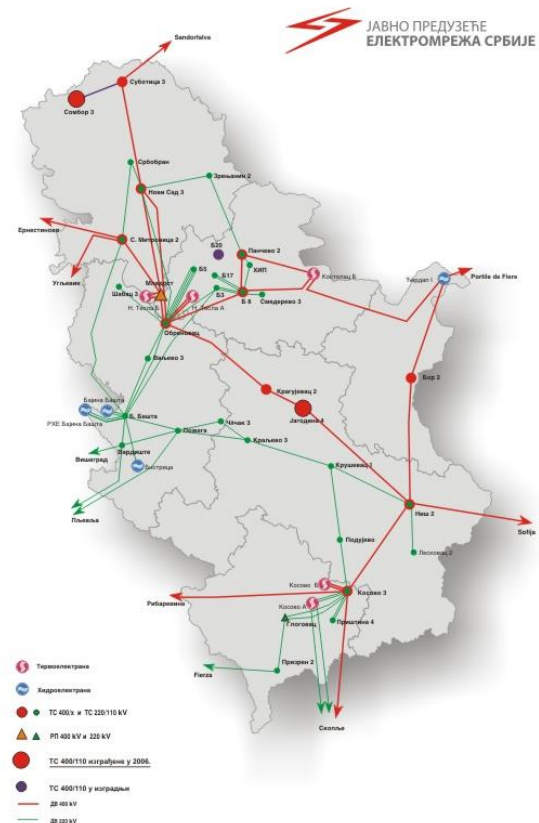
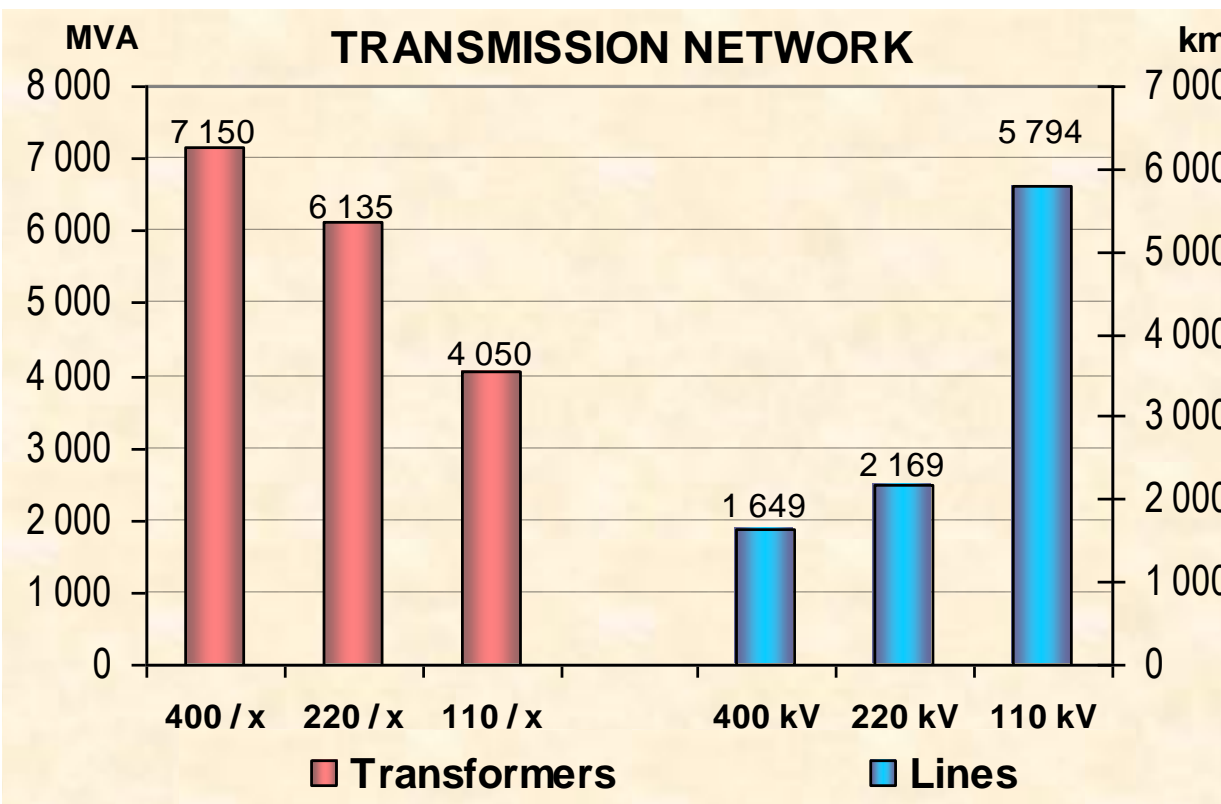

Distribution infrastructure

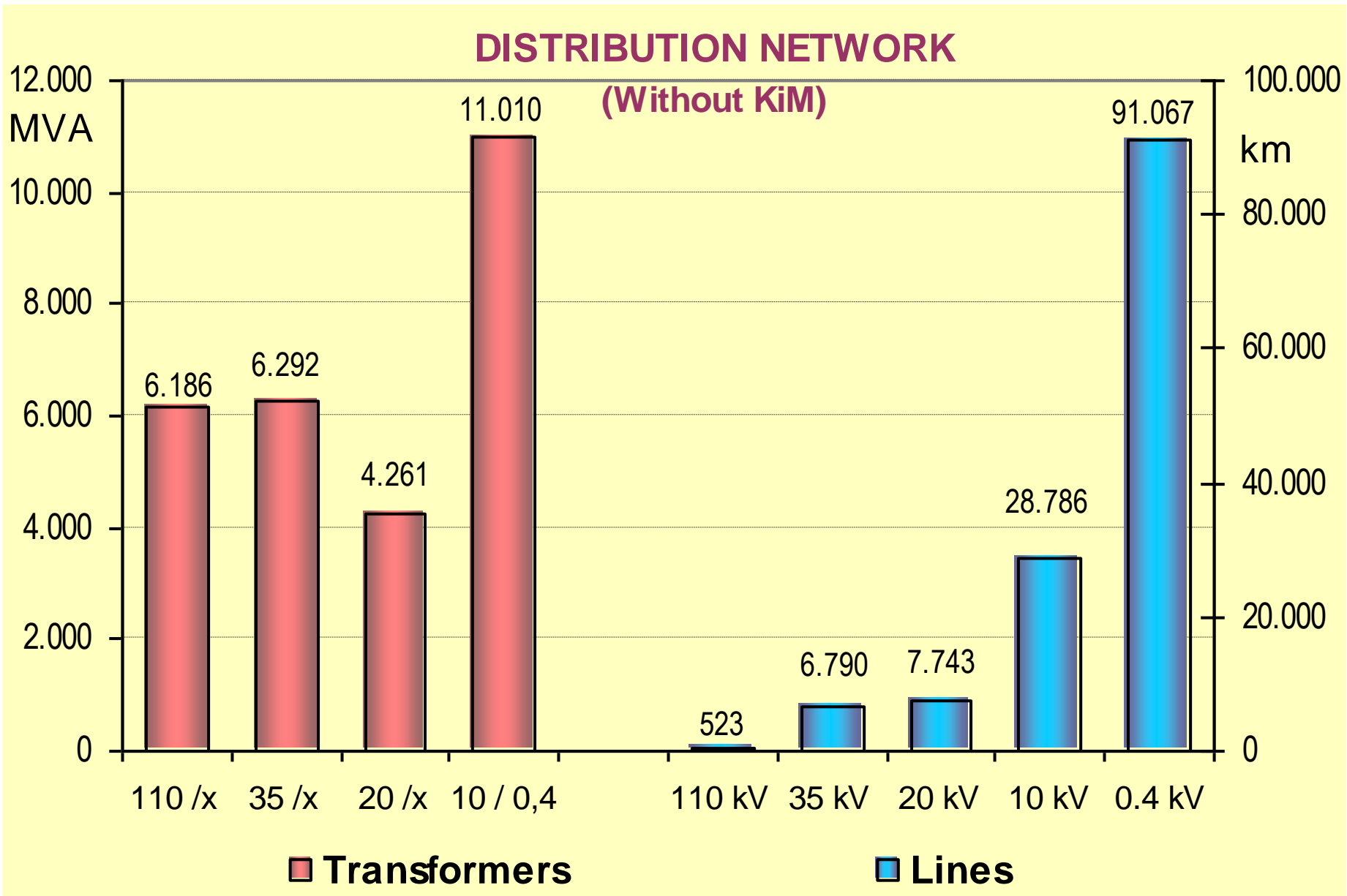

Topics of Interest

- The extent of market liberalization in Balkan markets: what are the opportunities and obstacles for new entrants?
- SEEPEX: new power exchange and possible solutions for market integration
- Are existing “energy-only” markets capable of ensuring security of supply?
- Co-existence of OTC bilateral and power exchanges trading
- The role of PXs in defining regional electricity prices
- Market coupling and cross border trading in the region?
- Creation of the transparent regulatory environment and timely implementation of the Network Codes

Serbian Electricity Market

- **New Legal Framework**
- **Electricity market model & market participants**
- **Assessment of market share**
- **Supplier of final customers**
- **DSO role in the market**
- **Recommended content of the bill**
- **Supplier switching process in the retail electricity market**
- **Closed electricity distribution system**
- **Predictions for 2015**

New Legal Framework

- 1) **EU 3rd Energy Package, Directives and Regulations**
- 2) **Decisions of the SEE Ministerial Council**
- 3) **Energy Law 2014**
- 4) **Bylaws under preparation**

The New Energy Law (EL)

- **Approved in December 2014**
- **2 trading licenses exist:**
 - **Wholesale Supply**
 - **Supply (of final customers)**
- **More liberal licenses conditions for wholesale supply**

Existing Bylaws based on EL 2011

2nd Energy package

Energy Law 2011

✓ TSO Grid Code

✓ DSO Grid Code

✓ Rules for the allocation of cross-border transmission capacities

✓ Market Code - Balancing responsibility

✓ Supplier switching rules

✓ Methodologies for determining electricity transmission and distribution use-of-system charges

✓ Methodologies for determining the price of electricity public supply

New Network Codes

3rd Package - NCs

➤ Production changes

- Increased generation of electricity from RES
- Increased generation on distribution network

➤ Consumption changes

- Increased Demand Side Response (DSR)
- Customers becoming consumers
- Increased use of new appliances (electric vehicle)

➤ Market integration

- Increased cross-border trade
- Coupling of electricity markets

Comparison of EU NCs & existing Serbian NCs

Connection Related Codes

- Requirements for Generators - TSO/DSO GC
- Demand Connection Code - TSO/DSO GC
- HVDC Connection Code - TSO GC
- Connection Procedures - TSO/DSO GC +

System Operation Related Codes

- Operational Security Network - TSO GC
- Operational Planning & Scheduling - TSO/DSO GC
- Load Frequency Control & Reserves - TSO GC
- Operational Procedures in Emergency - TSO/DSO GC
- Staff Training NO

Market Related Codes

- Capacity Allocation & Congestion Management - CA&CM TSO
- Forward Capacity Allocation - CA TSO
- Balancing Network Code - MC TSO

New Electricity Law - Market Participants

- 1) Generation
- 2) Wholesale Supplier
- 3) Final Customers' Supplier
- 4) Final Customer
- 5) Transmission System Operator
- 6) Distribution System Operator
- 7) Closed Electricity Distribution System Operator
- 8) Market operator (spot market)

Electricity Retail Market Share in 2014

Gross consumption is 34.0 TWh

TWh

REGULATED MARKET ↘		COMPETITIVE MARKET ↗	
Households	14.1	Customers on competitive market	8.3
		TPP, HPP consumption	0.5
Small customers	5.6	TSO losses	1.0
		DSO losses	4.5
Total	19.7		14.3

Final consumption is 28.5 TWh

Market openness is 31%

Expected: new 2TWh on free market

Suppliers' activities during 2012 and 2013

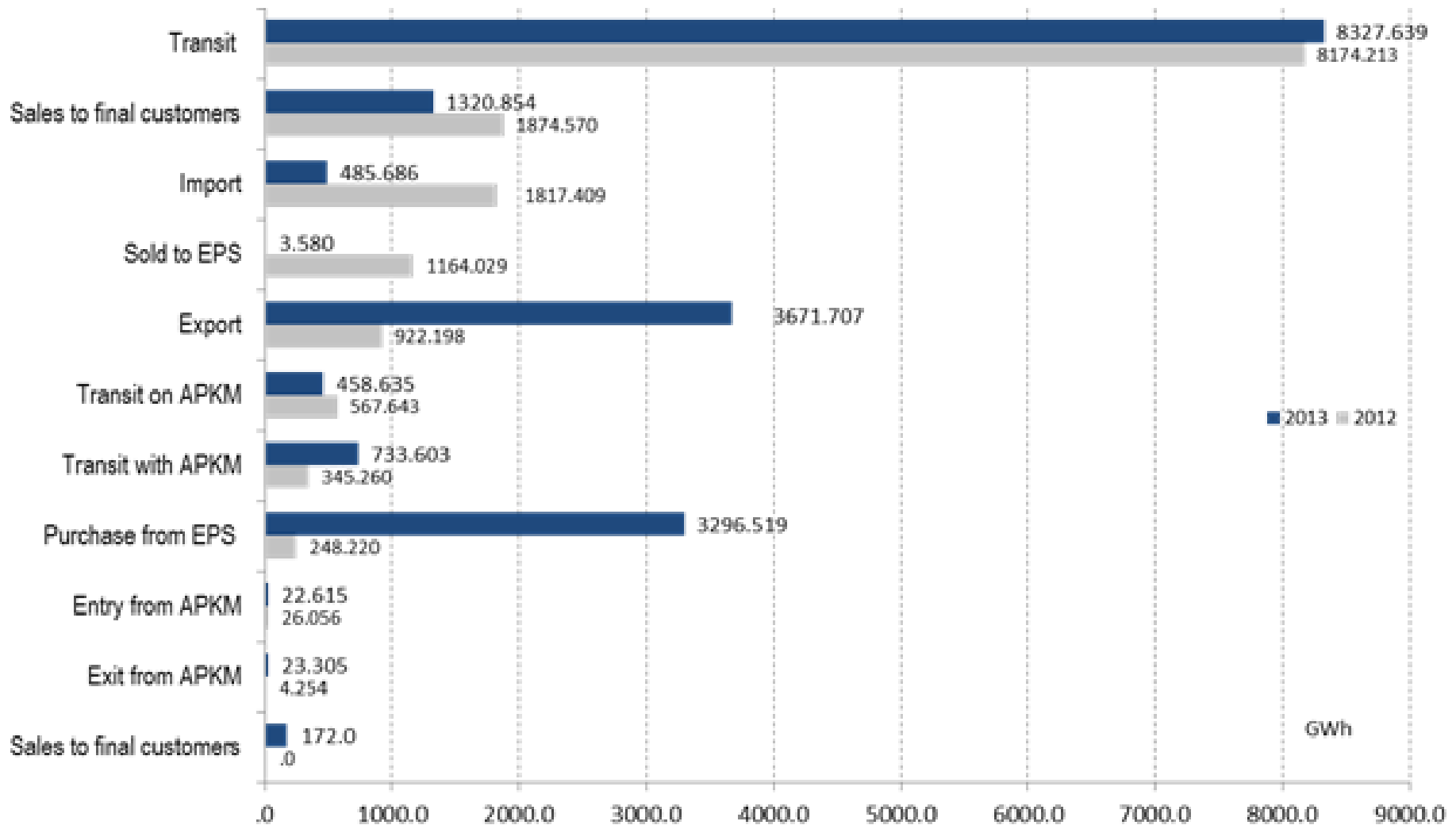

86 licenses
44 BRP

Final Customers' Supplier

- **Generation**
- **Supplier**

Contract on final customers supply

- ***Full supply (you pay as much as you consume)***
- ***Supply with quantity of electricity determined in advance (according to the consumption diagram in line with quantities contracted in advance + BR contract)***

at one metering point, they can not be combined !

DSO Role in the Market

- **Guarantees the ability and accuracy of measurements**
- **Maintains a database of suppliers, contracted metering points and the expiration date of the contract**
- **Informs the Reserved and the Public supplier if the measuring point is not covered by contract**
- **Provides metering data to customers and their suppliers**
- **Load profiles**

Supplier Switching Rules

- **Rules** for retail market
- **Regulated financial obligations** to the current supplier
- **Process** is driven by a new supplier
- The **significant role** of the **system operator**
- The **day** of the **supplier switching** is the **same** as when the **meter was read**
- **Free of charge** for customers
- Takes **21 days** maximum

Closed Electricity Distribution System

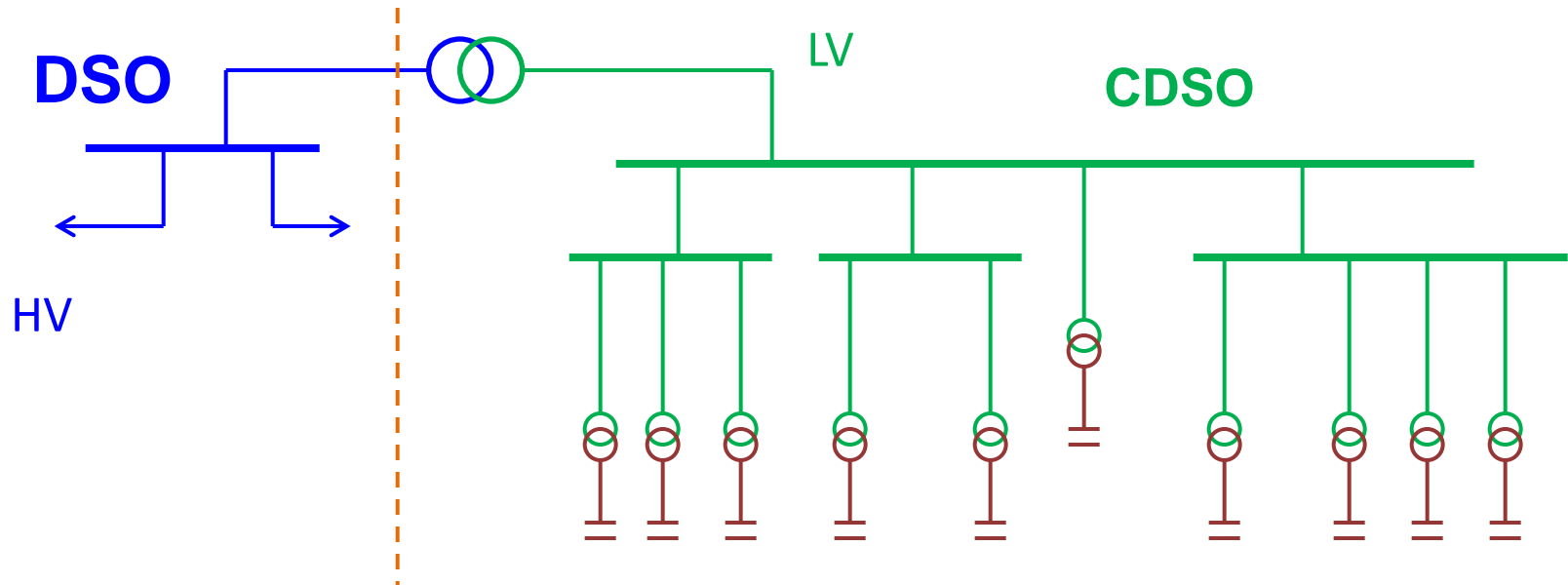

EL 2014

- 1) Who can be the Operator of CDS
- 2) The rights and obligations of the Operator of CDS
- 3) Rights of customers connected to the CDS

CDS - Goals

- 1) Customers connected to the network OCDS can choose any supplier at competitive market
- 2) Maintenance and recovery of CDS is provided
- 3) Adequate measurement and meters reading

Problem: The initial financing of the system preparation for licensing

- OCDS may have a license for the supply in the open market (<100,000 customers)
- Electricity and network access are purchased at HV and sold on LV
- Optimizing access prices + supply

YEAR 2015 Achievements

- **Organized markets** (Power Exchange of Electricity)
- **Competitive market** could be **increased**
 - Customers who lose status of a small customer due to a limit of yearly consumption to 30,000 kWh (+2TWh)
 - Households with consumption in the red zone
 - Some other consumption at LV
 - Industrial consumers within Closed Distribution Systems
 - Number of small customers will be decreasing

SOUTH EAST EUROPE REGIONAL ELECTRICITY MARKET



Implementation of EU energy legislation in the Energy Community: Legal framework

- EnC acquis defined by EnC Treaty
 - including Third Energy Package MC Decision 2011/02/MC-EnC
 - implementation deadline 1 January 2015

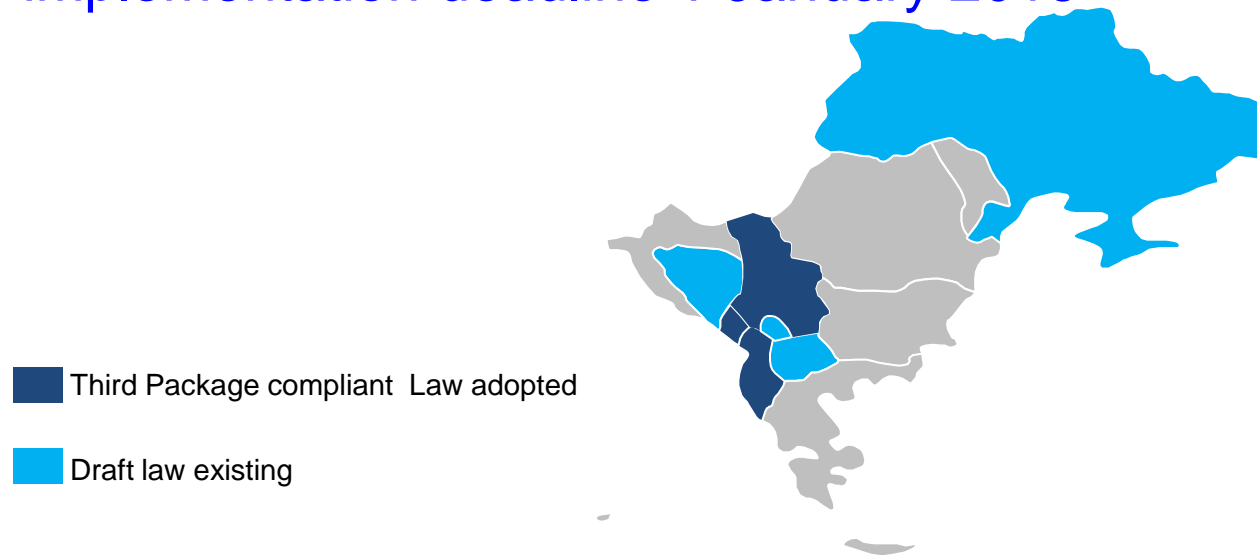

- Including commitment to implement Network Codes / Guidelines Article 27 of MC Decision 2011/02/MC-EnC | Article 18 Electricity Regulation (EC) No 714/2009 ²²

Implementation of new acquis

- Standard procedure
 - Decision of the Ministerial Council
- Network Code procedure

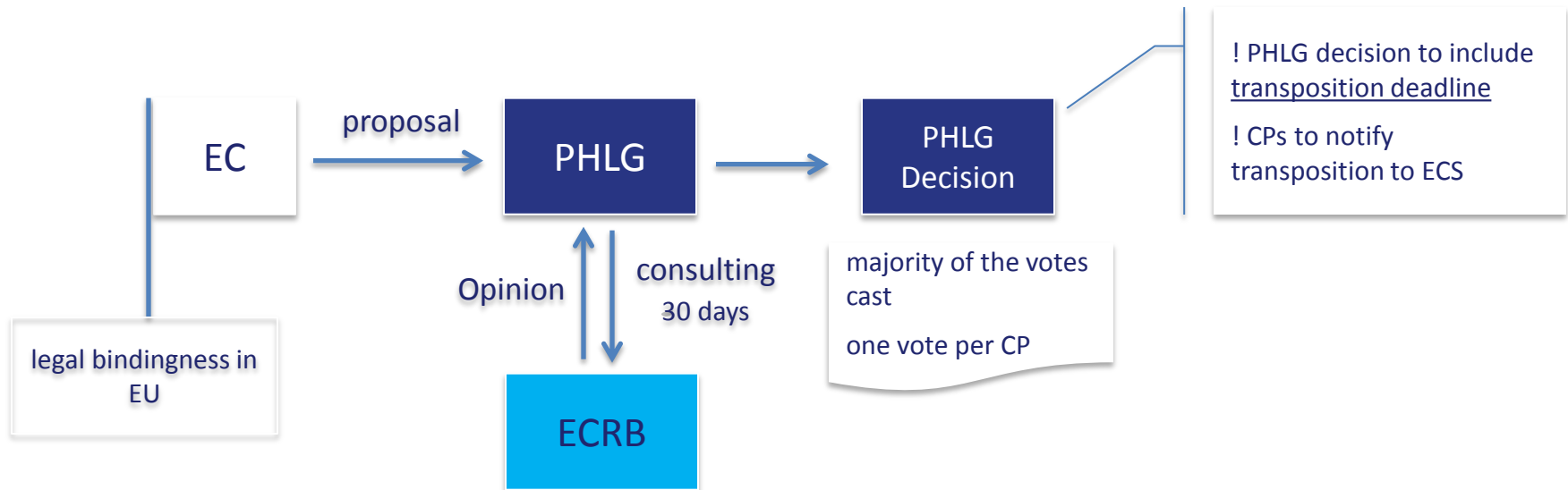

European *acquis*

- 1) The first Regulation issued by the EC on market integration is the Commission **Regulation (EU) 2015/1222** establishing a **Guideline on Capacity Allocation and Congestion Management (“CACM Regulation”)** entered into force on 14th August 2015
 - 2) A second **Regulation on Forward Capacity Allocation (“FCA Regulation”)** was adopted by Member States on 5th October 2015 and it is expected to enter into force in 2016
 - 3) Finally, the comitology process for a **Regulation on Electricity Balancing** is expected to start in 2016
- All these three Regulations have to be **considered** a **relevant part** of the European *acquis* and, as a consequence, should be **adopted by the PHLG** and **transposed** in the legal framework of EnC CPs
 - **ECRB** has already made several times a **strong plea** for the **timely** and content wise coherent **implementation** of the NCs in the EnC without unnecessary delay

Reciprocity and
common legal rules
needed for technical
operation of
interconnected
networks and
integration of
markets!

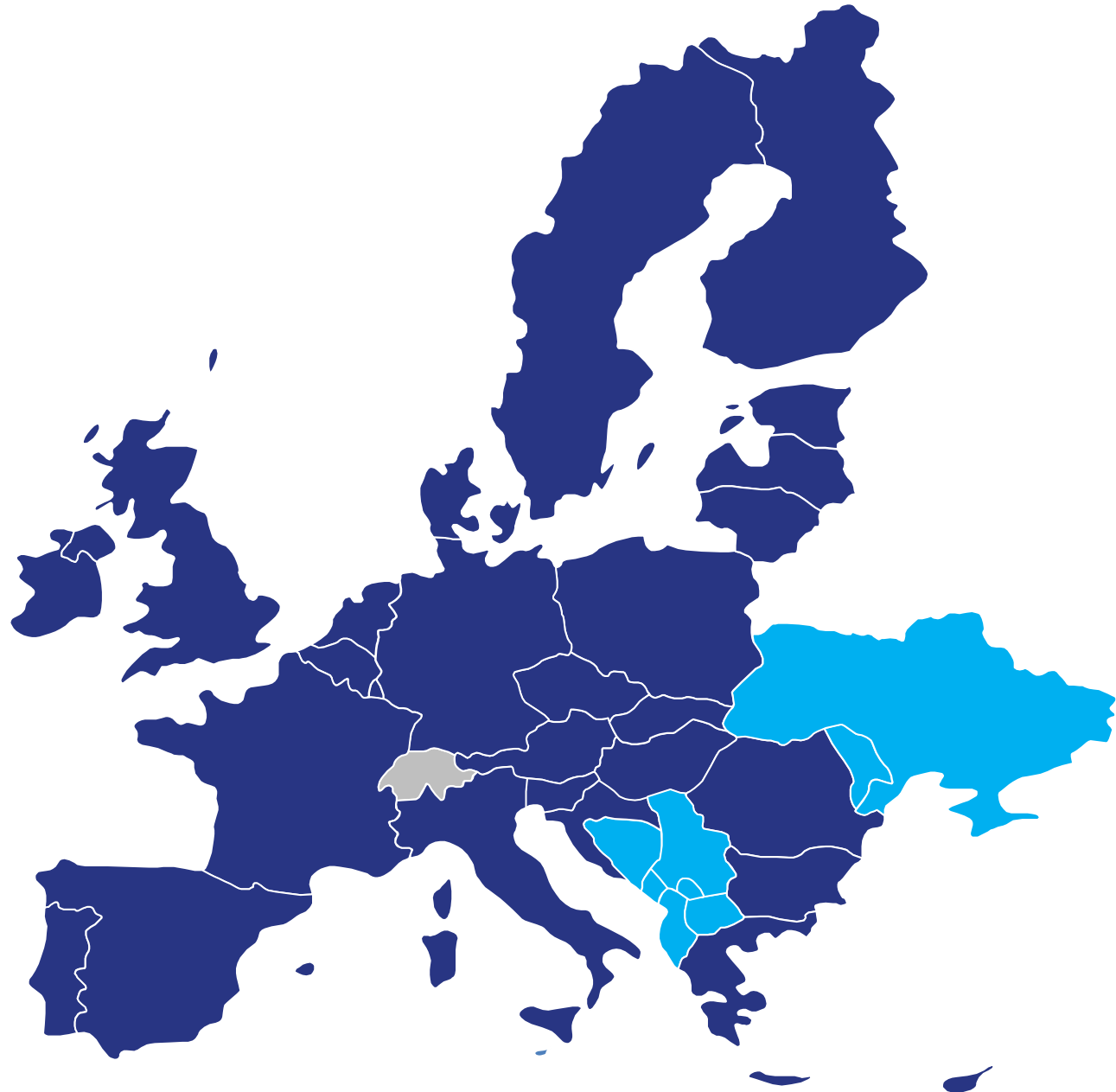

The 8th Congestion Management Region - SEE

- The so called 8th Congestion Management Region was established according to the approach used within the EU (EREG Electricity Regional Initiatives)
- The agreement on the South East European region was reached at the Ministerial Council in June 2008: The 8th Region was created by MC decision in June 2008
- The definition of the 8th Region was an important step towards the establishment of a SEE Regional Market for electricity
- As a result, a common Coordinated Congestion Management method, including capacity allocation, is to apply for the **following territories**:
 - the **eight** Energy Community Treaty **Contracting Parties**
 - the neighboring countries **Bulgaria, Greece, Hungary, Romania, Croatia** and **Slovenia**
 - **Italy** with regard to the interconnections between Italy and the CPs to the EnC Treaty (DC undersea cables)
 - **Moldova** and **Ukraine** are not technically in parallel synchronous operation within ENTSO-E, and thus cannot perform operationally CACM mechanisms in the 8th region

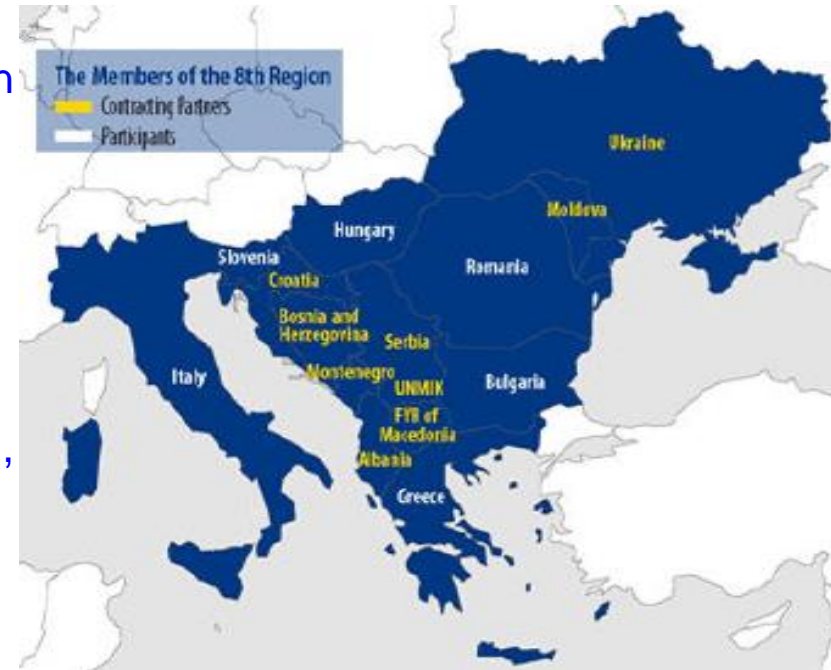

SEE
8 contracting parties
>20 borders
Population: 137,12 million

- CEE and SEE TSOs decided to implement **Explicit Flow-based CA** mechanism in SEE Region ... vs. CWE, SWE and Nordic Region where Implicit NTC based mechanism is implemented (Market Coupling, Market Splitting)
- Coordinated Auctions and **SEE CAO** are **in compliance** with Regulation 1228/03 (714/2009) and CACM provisions
- Establishment of SEE CAO targets harmonisation of the allocation and nomination rules for Long and Short term transmission rights in the 8th Region
- EnC MC in December 2008 supported the location of SEE CAO in Montenegro
- Project Team Company in Charge of Establishing SEE CAO (PTC) has been officially registered in Montenegro on 4 July 2012 with the scope of preparing the effective operation of the SEE CAO (www.seecao.com)
- SEE CAO Company shareholder agreement by the TSOs of Albania, Bosnia and Herzegovina, Croatia, Greece, Kosovo*, Montenegro and Turkey
- **SEE CAO started to operate in 2013**
- First allocation procedure were organized by SEE CAO: Yearly allocation for Q1 2015: an initial step towards centrally coordinated forward capacity allocation
- NTC based approach for SEE CAO as the first step
- SEE TSOs drafted Auction Rules and SEE Regulators approved SEE CAO related rules and will perform CA and SEE CAO Monitoring + define revenues distribution
- Obstacles for participation: VAT problem (FYROM); Albania joining; Serbia activity plan

Third Energy Package

- On EU level, the entry into force of the Third Energy Package together with the target of completing the internal energy market by 2014 form the framework for electricity market development
- **Third Energy Package** was **incorporated** in the Energy Community in **October 2011** with a transposition deadline by **1 January 2015**
- This also includes adopting the **European Network Codes**, once legally binding on European level, in the Energy Community (Decision 2011/02/MC-EnC of the Ministerial Council of 6 October 2011)
- Ukraine has abstained from approval of the decision until the internal state procedures of ratification are performed
- Network Codes will, finally, have the form of a directly binding Regulation
- Different from EU, European Regulations **do not develop direct applicability** in the Energy Community but **need to be transposed into national legislation**
- The Energy Community Council by Decision 2011/02/MC-EnC **empowered** the Energy Community Permanent High Level Group (**PHLG**) to decide on the **applicability of the European Network Codes** and Guidelines in the **Energy Community**

South-East Europe Regional Action Plan

- The goal of integrating the seven European electricity regions into a single market area is addressed through the *Regional Initiatives* process which falls under ACER's responsibility and focuses on four **cross-regional roadmaps**:
 - Capacity calculation
 - Long term capacity allocation
 - DA capacity allocation (Market coupling)
 - Continuous mechanisms for implicit cross border intraday trading
- **8th Region** participates in **ACER's** coordinated **Monitoring activity**
- **SEE RAP** defines the **steps** for **regional market integration** in the 8th Region streamlined with the milestones and actions of the European *Electricity Target Model* and the four cross-regional roadmaps

Action needed to overcome the identified constraint(s) in SEE RAP

- **All elements of SEE RAP** can be implemented within the legal framework of the **2nd Energy Package**
- Establishment of a regionally coordinated congestion management is explicitly required by Regulation (EC) 1228/2003
- However, **stronger political support, promotion and commitment are necessary to proceed**
- Fully regionally coordinated allocation process for the entire 8th Region **still lacks participation** of Bulgaria, FYR of Macedonia, Romania and Serbia
- **Athens Forum in 2014** highlighted the **need for TSOs** of Bulgaria, Macedonia and Serbia, which so far have not participated in SEE CAO, to **come up with concrete plans and timelines** regarding their **participation** in a regional capacity allocation body
- Romanian stakeholders indicated clear commitment, once the neighbouring bidding zones' TSOs are cooperating within SEE CAO
- **Serbia** established **Power Exchange SEEPEX** in 2015; **DA** operation started on 17 February 2016; **open for MC** and offering services
- Plans for Market Coupling with Hungary / 4MC one year after starting operation

Conclusions on SEE RAP development

- **Still existing lack of a regionally coordinated capacity allocation mechanisms** remains a key concern, both in terms of market liquidity as well as compliance with the EnC *acquis communautaire*
- **Insufficient transmission interconnection capacity with neighbouring systems** remains a **key barrier** for limited cross-border trading and the establishment of a Regional Electricity Market / PECEI project
- **Coordinated capacity allocation** and congestion management schemes are therefore **essential**
- Although TSOs of all EnC CPs, except Moldova, have already introduced market-based capacity allocation mechanisms (based on NTC auctions) for congestion management at their borders, **there is still insufficient harmonization in the 8th Region**

Mechanisms for Capacity Price determination in the 8th Region (Q1 2015)

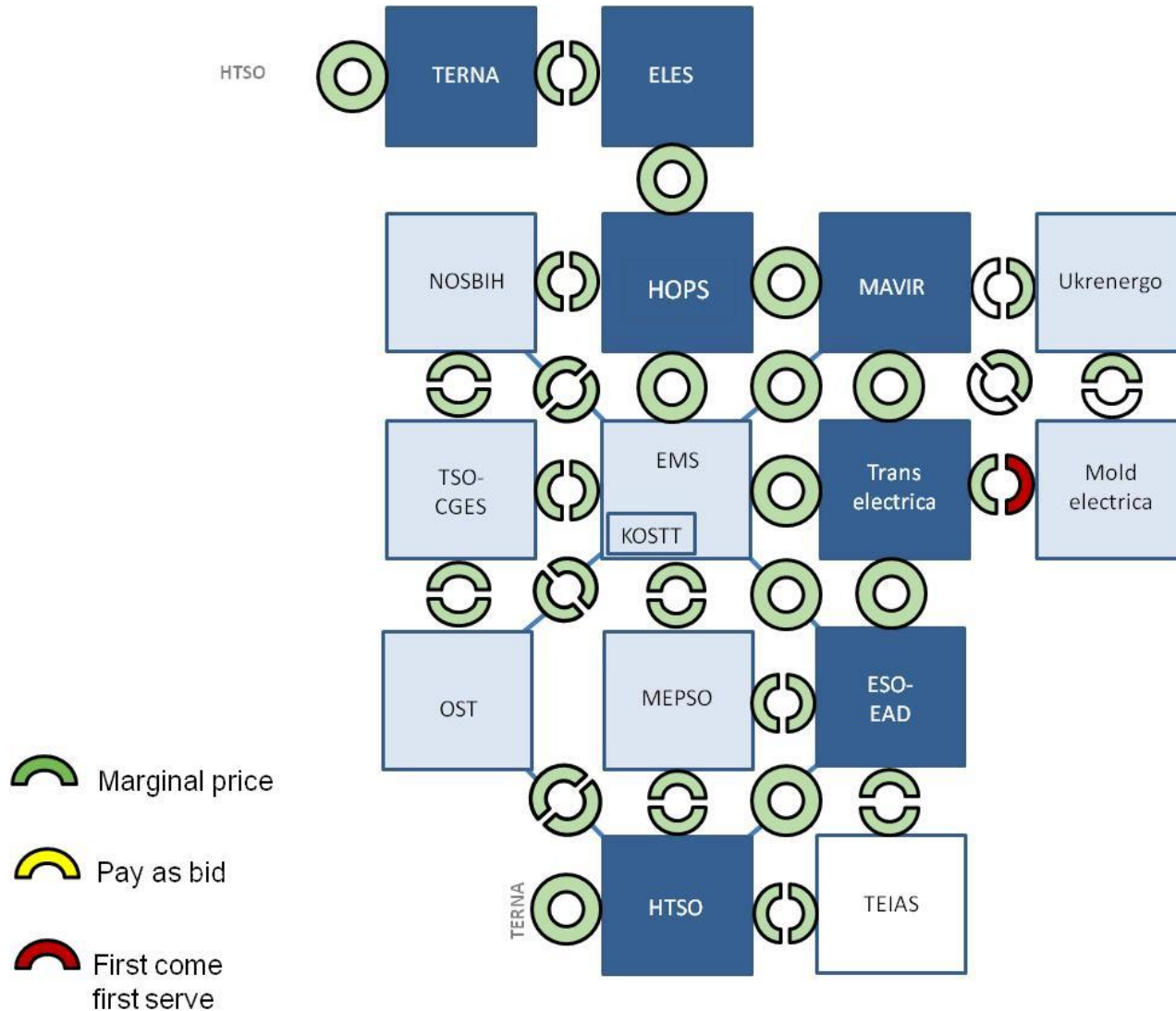

Cross Border Capacity Allocation Mechanisms in the 8th Region (Q1 2015)

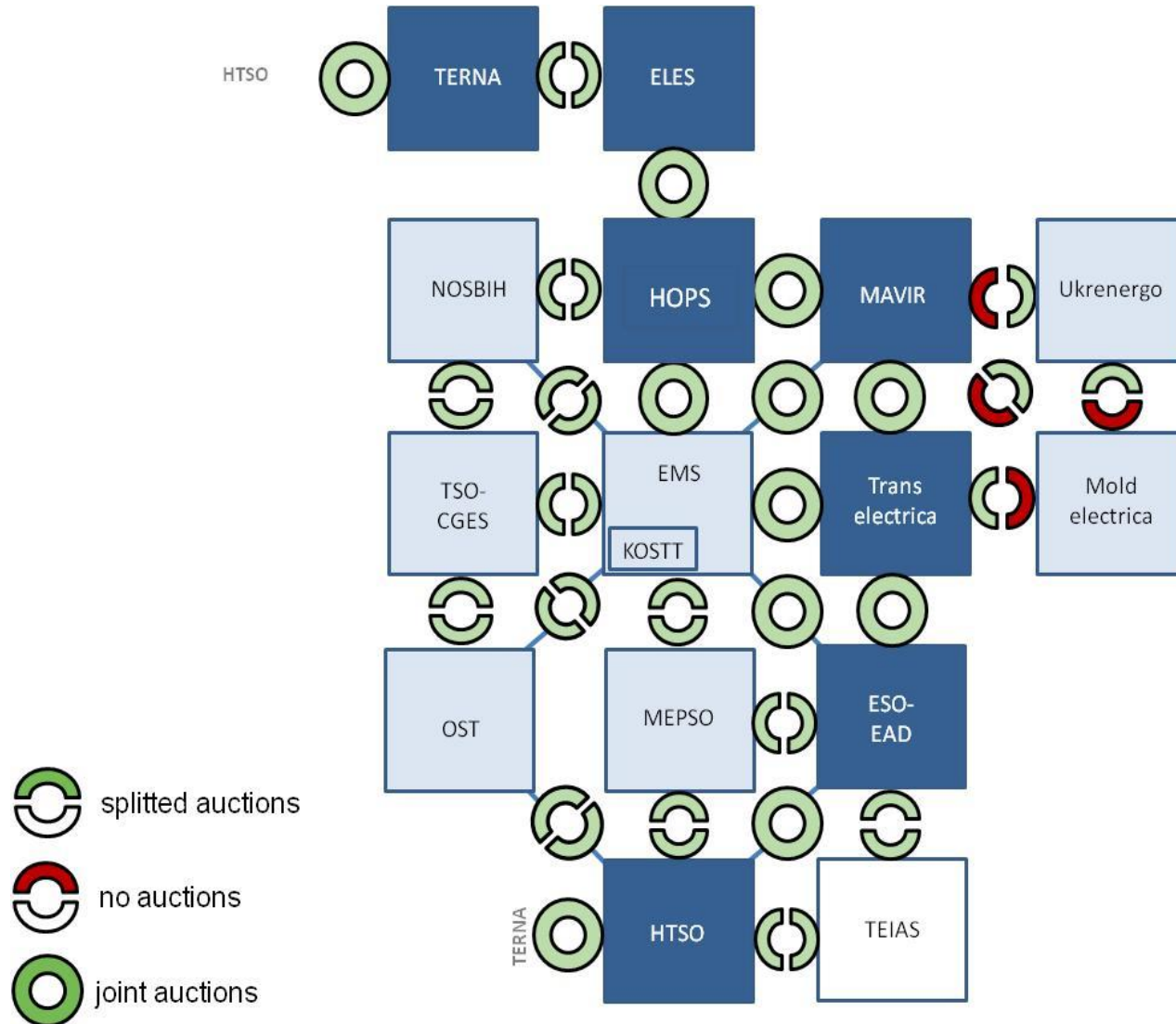

CA Joint auctions

- **All CPs TSOs**, except TSO of Moldova, have **introduced market-based mechanisms for cross-border auctions**, namely **explicit NTC-based auctions**
- With regard to the Republic of **Moldova**, the draft regulation transposing Regulation (EC) 1223/2008 has been finalised with further amendments; **approval** is, however, **pending** and subject to adjustments in primary legislation
- Auction rules for cross border capacity allocation for the borders of **Ukraine** have been **adopted by NRA**; these Auction Rules are, however, **not in compliance with the EnC acquis**. Yearly and monthly allocations are introduced at all electricity borders while weekly and daily allocations are introduced only at several borders. Intraday allocations are also available at several borders, but on non-market based solution (first come, first served)
- **CPs TSOs** have **started to implement joint auctions**
- Croatian borders to Slovenia and Hungary are for the first time involved in **CEE CAO** (Y, M and D auctions) in 2013

SEEPEx partners: about EMS

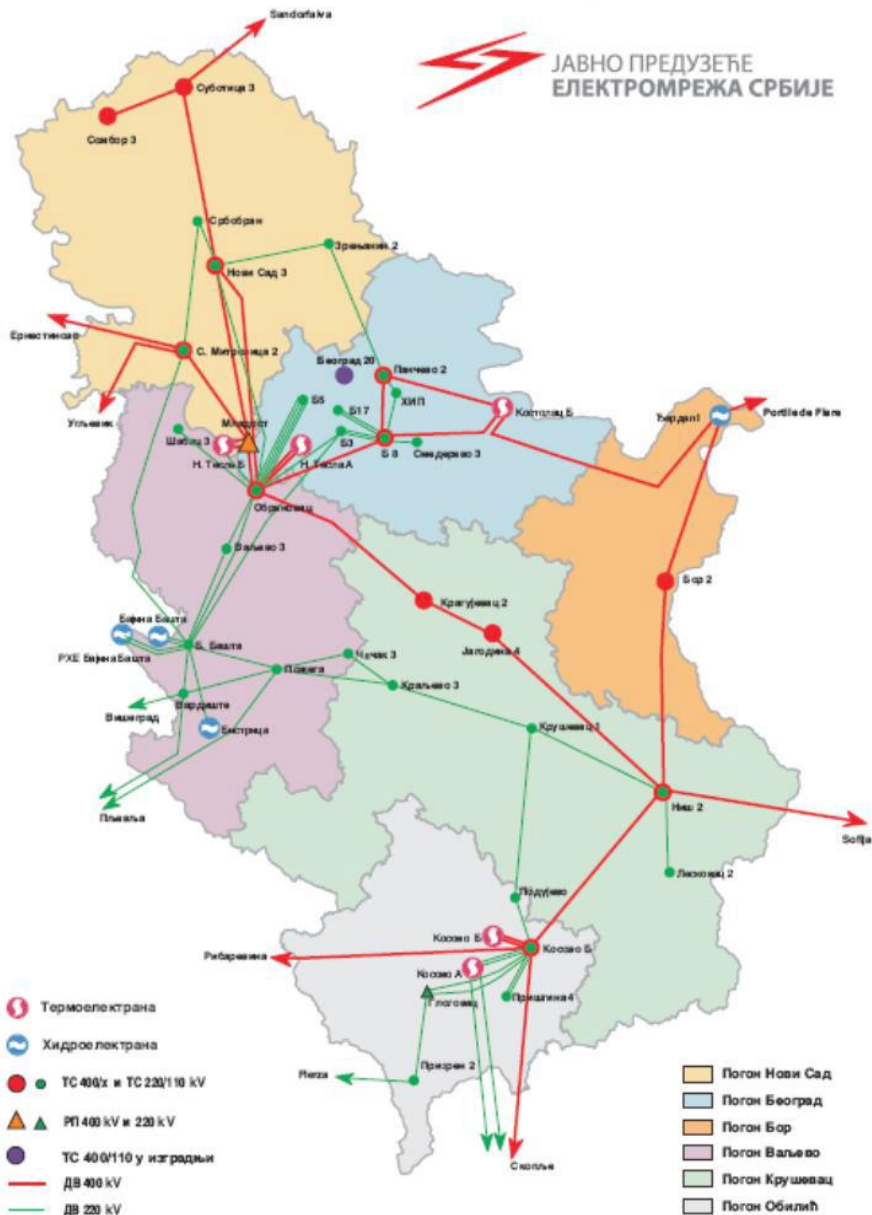

- According to the new Energy Law (adopted in Dec 2014), JP EMS was entitled to develop and establish Serbian Market Operator and organized electricity market

JP EMS core activities:

- Transmission
- System Operation
- Market Operation (TSO Market functions)

- Transmission – 400, 220 and part of 110kV network (installed power in EMS substations is about 19 500 MVA, HV Lines length 10.000km)

- System Operation – two layers of grid control (National DC in Belgrade and Regional DC's)

- Market Operation – Development and administration of the Serbian Electricity Market

SEEPEX IMPLEMENTATION – legal aspects

- SEEPEX is the result of the **close cooperation between EMS and EPEX SPOT** 
- SEEPEX is designed to be a **customer-oriented company**
- SEEPEX will rely on EPEX market operation (ETS)
- Best practice in high transparency and surveillance standards
- JP EMS has provided Ministry with the Basic principles for SEEPEX establishment – JP EMS – SP cooperation envisaged – **EPS as Market Player** in order to provide SEEPEX liquidity in the early stage?
- Energy Law amended – Organized market
- Ministry supported organizing SEEPEX
 - EU Directives and Regional Action Plan elaborated
 - JP EMS – Strategic partner cooperation recognized
 - Pave the way for the next steps – Ministry of Energy, Ministry of Economy and Ministry of Finance supported appropriate realization of the SEEPEX establishment

SEEPEx IMPLEMENTATION

The right momentum...

- The **necessary legal and regulatory changes** have been implemented in Serbia to **support** the establishment and the smooth functioning of an organized power market:
 - The **Third Energy Package** is enforced (new Energy Law enforced in December 2014)
 - **Foreign companies** are entitled to **directly trade** on the wholesale market in Serbia since this enforcement
 - The **VAT law** is being **amended** in order to introduce VAT representative role and set-up a reverse charge mechanism in the electricity trading
- The establishment of an **organized market** is a logical next step in Serbia
- There are strong **expectations** and **requests** from the trading community to have a **price reference in Serbia**

SEEPEX – Clearing Service

- Clearing service is provided by ECC according to standard model in place in other European countries

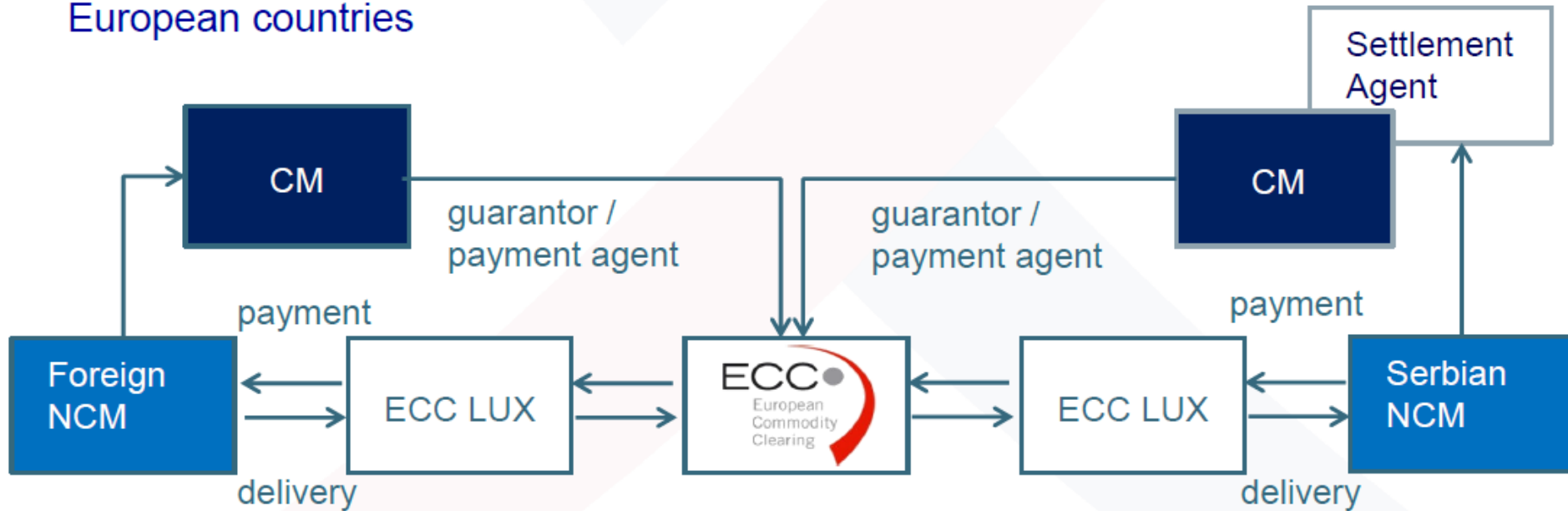

SEEPEX – Business Model

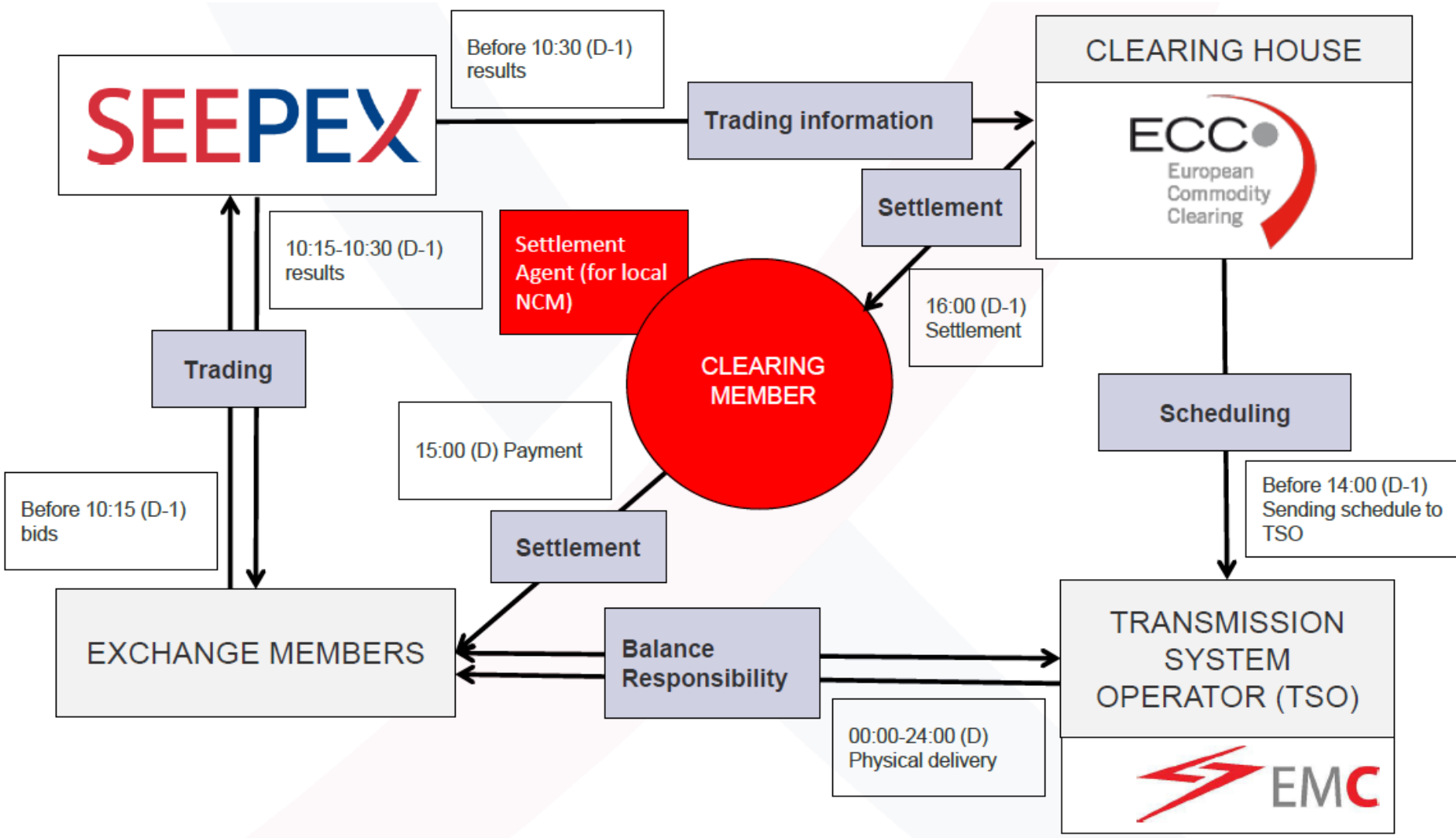

SEEPEx Strategic Goals

- Ensure a **transparent** and **reliable** wholesale **price formation mechanism** in Serbia
- **Cooperation** with the Strategic Partners (from EU and the SEE region)
- **Via standardised** and harmonised **trading and clearing rulebooks and processes** reducing market participants' trading costs
- Provide market participants with a **transparent, cost-efficient** and **secured trading facility** using best **surveillance standards**
- Highly effective and efficient **clearing** and **risk management services**
- Access to a **wider range of products**
- Facilitate more effective **governance** and implementation of **Market coupling projects in SEE**
- Development of a **single regional** trading & clearing & settlement **infrastructure - developing relevant and reliable price indices** for each price zone
- Market participants will **benefit** from streamlined spot trading procedures, lower risks, financial security, and lower costs

SEEPEX Volume - Price Chart



Base Price comparison SEEPEX - 4MMC (HUPX&OPCOM)



Base Price Comparison 18 February–10 March

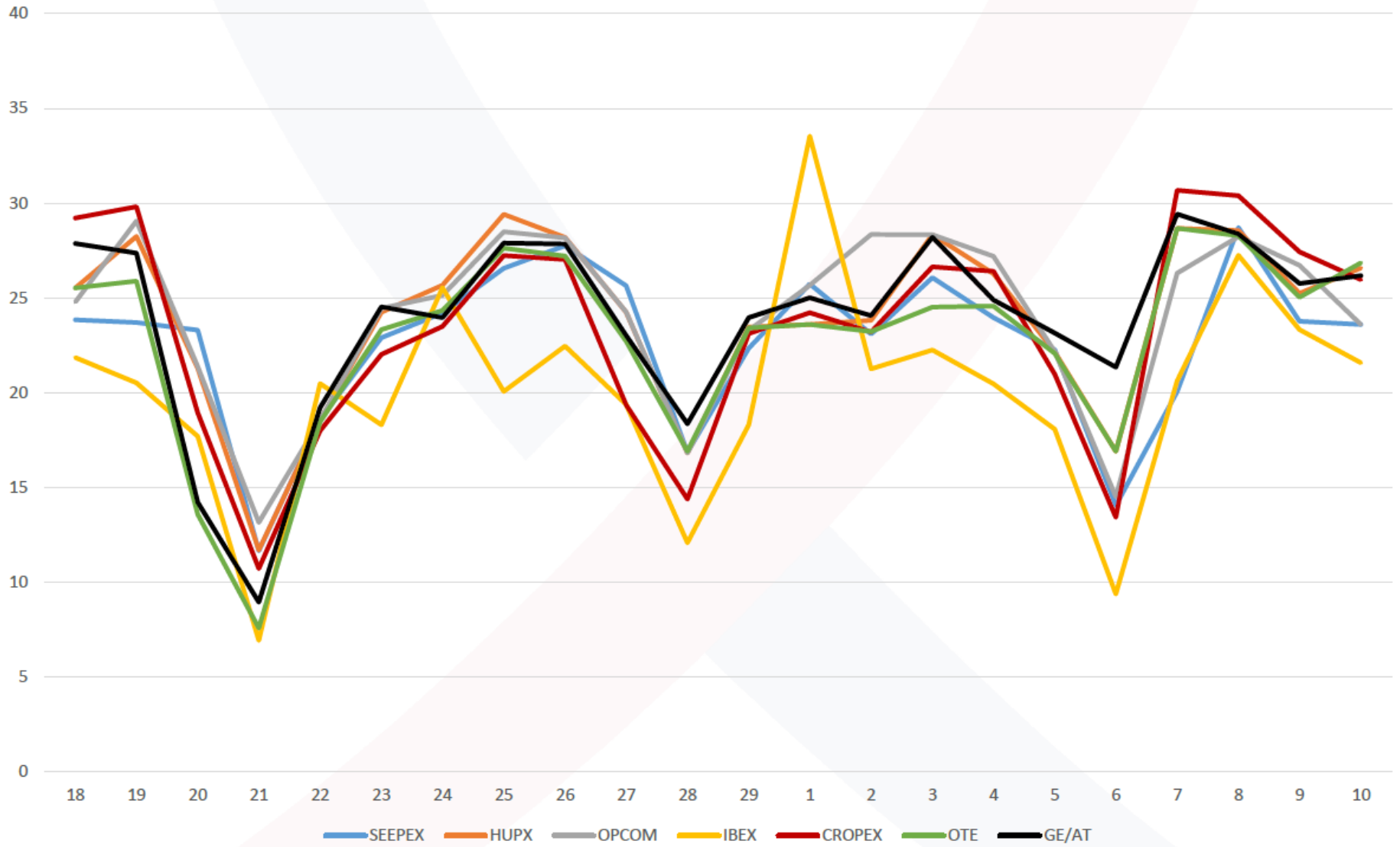

SEEPEX a step forward to market opening and regional cooperation

.... With the support of **regional initiative**

- **18th Athens Forum conclusions:**
- *11. The Forum supported the proposal to use the SEEPEX project as **pilot project** for setting up a **power exchange in the region** and to prepare coordinated day-ahead and intraday capacity allocation... The SEEPEX can be **extended to other Contracted Parties** on a **step by step** basis as soon as possible.*
- **Cooperation** with neighboring countries is highly expected and SEEPEX is naturally committed to **partnering** with other TSOs and PXs/Market Operators
- The **4MMC** was launched in November 2014: Serbia is a **natural extension** with its 2 borders with the 4MMC

Market Coupling

- The latest endeavours to establish Power Exchanges constitute a **move into the right direction towards the development of spot markets** and the provision of a condition for future implicit allocations
- The **establishment of a Power Exchange in Serbia by TSO EMS and EPEX SPOT** is the front-runner in these developments in the CPs of EnC
- **More details** on how other bidding zones will be involved in this project **are expected**
- **Most EU countries** of the **8th region** have **established trading hubs on a day-ahead level**, namely in Greece, Italy, Slovenia, Romania, Hungary and recently in Bulgaria and Croatia
- **Romania** joined **Market Coupling mechanism** between Czech Republic, Slovakia and Hungary; EPEX-Spot was selected as Service Provider by OPCOM/OKTE/HUPX

Day-Ahead Market 2013/2014

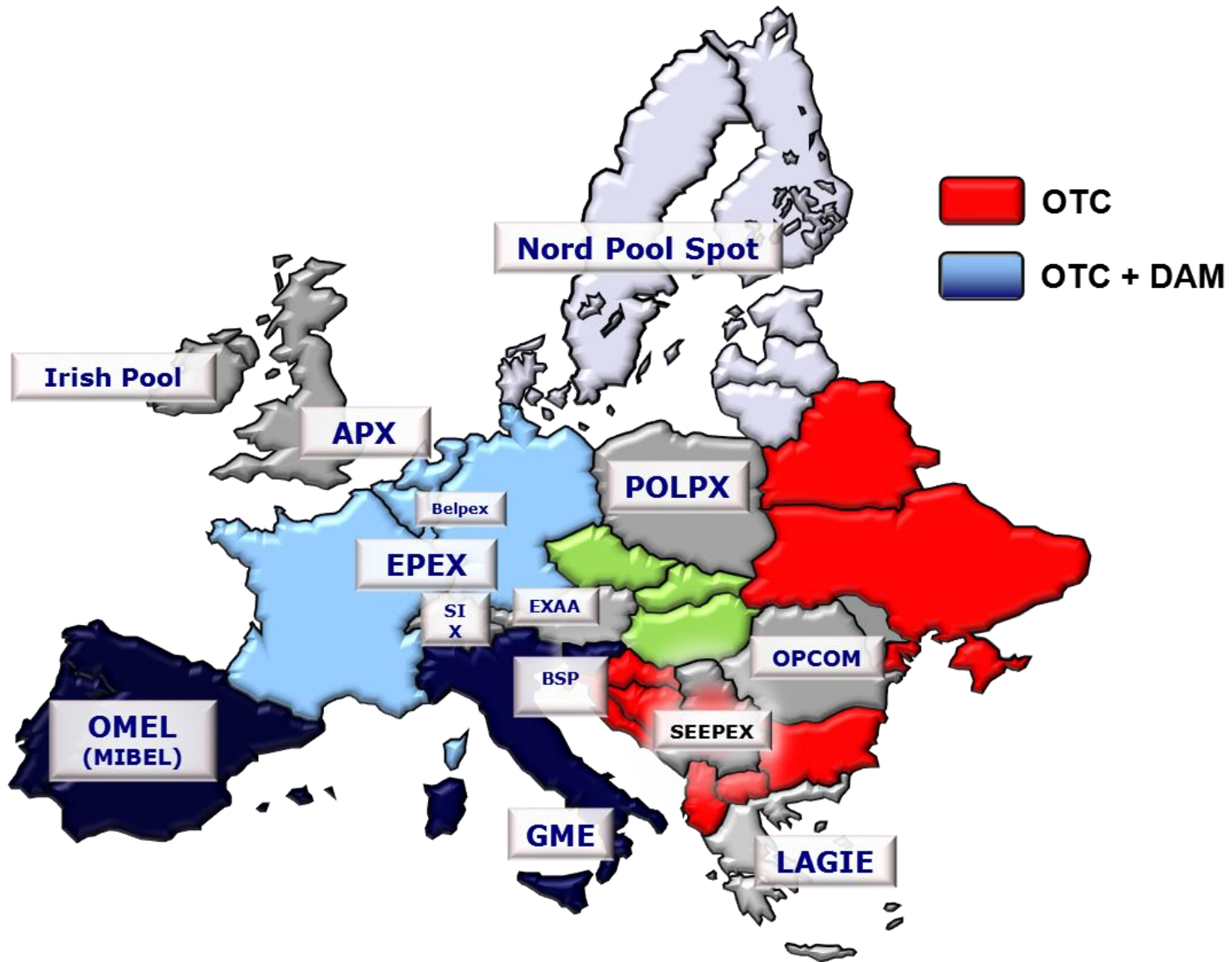

Day-Ahead Market: 2015

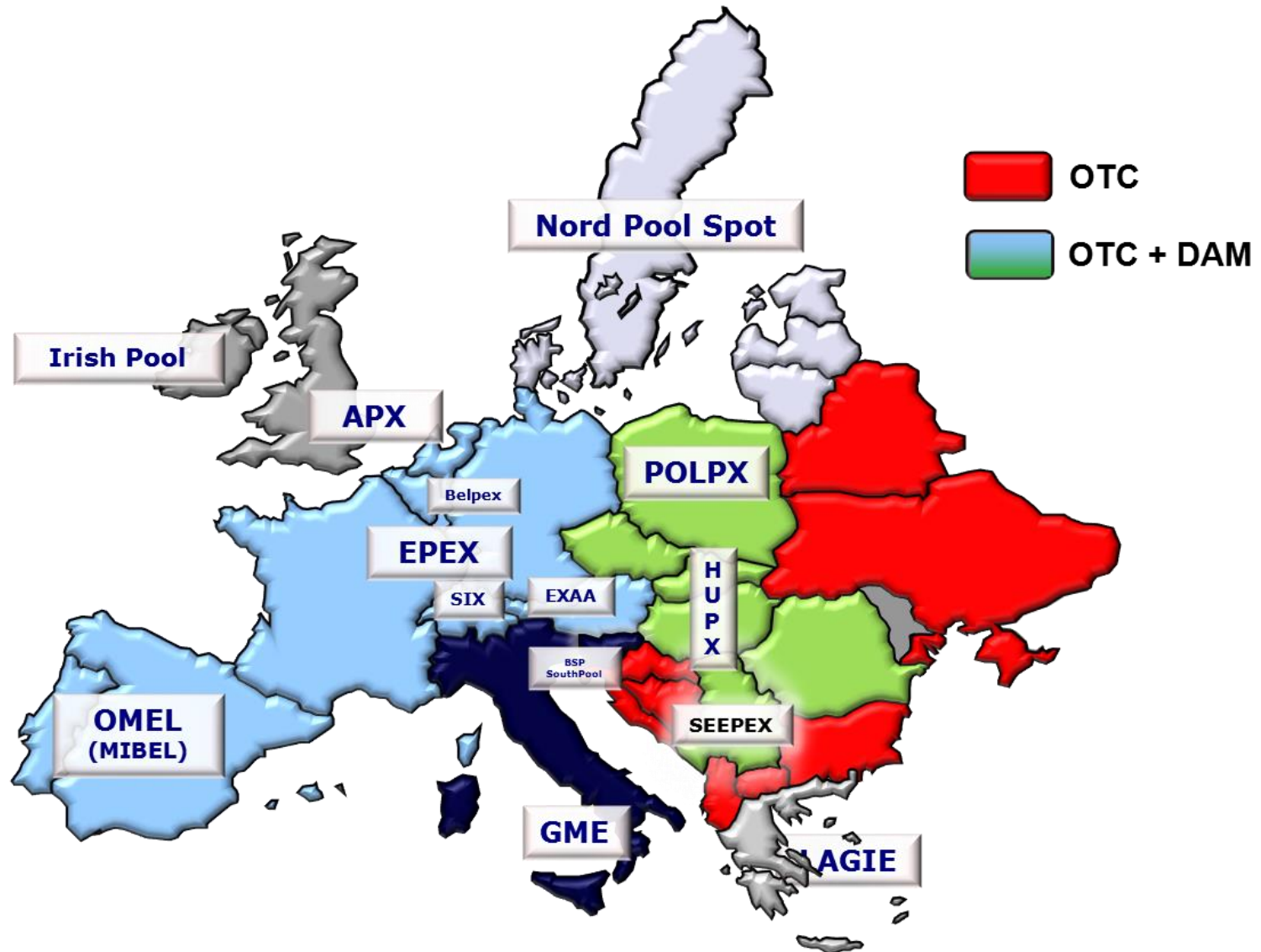

The 8th Region – Progress Maps – Establishment of PX (functionality) & Market Coupling

No concrete PX project planned

PX establishment / servicing on the way

PX established, without Market Coupling

Market Coupling implemented on some borders

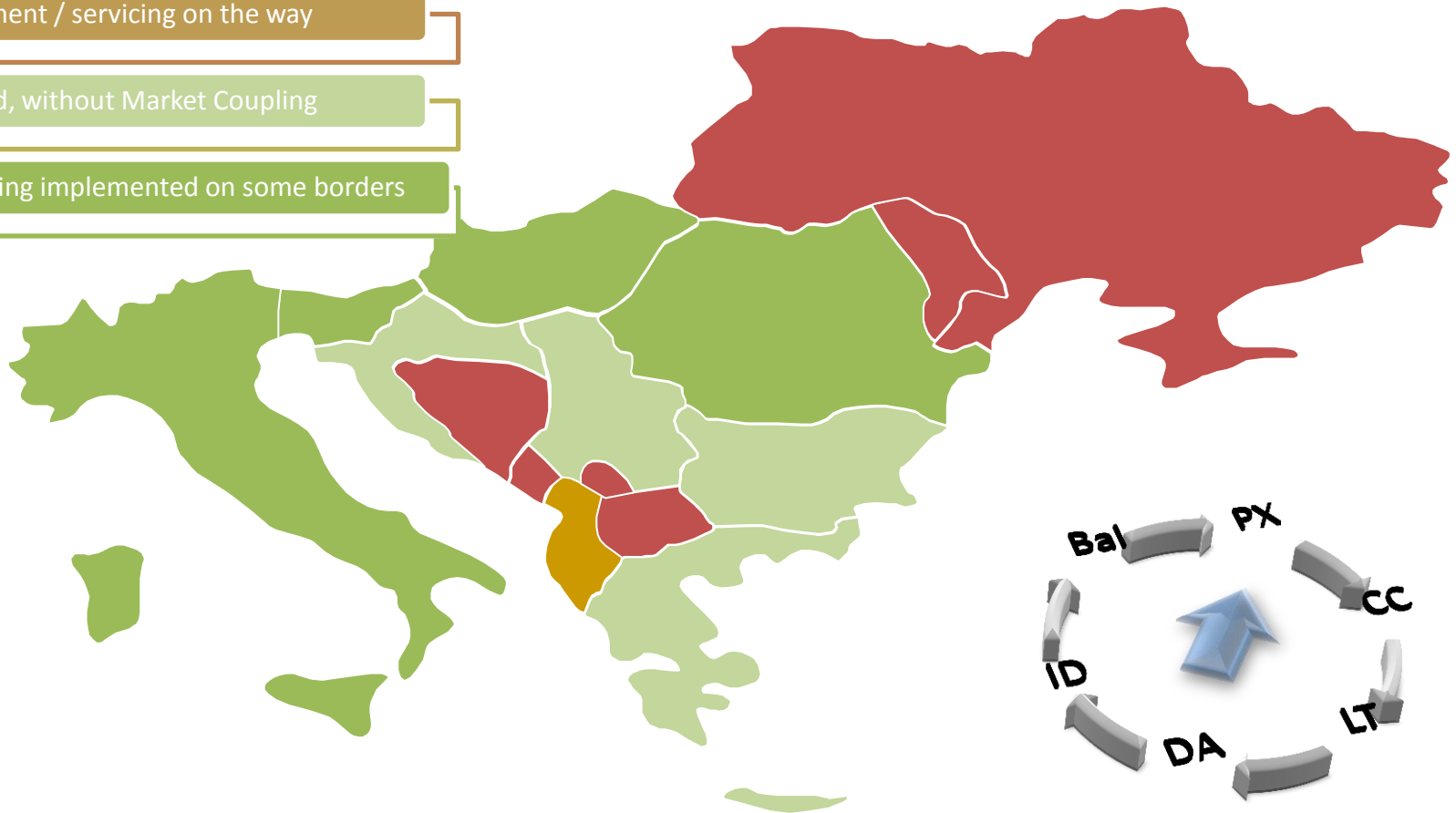

The 8th Region – Progress Maps – Coordinated Capacity Calculation

- No Coordination with 8th region neighbours
- LT CC & Outage coordination
- D-2 & ID Coordination
- Flow-based Capacity Calculation implemented

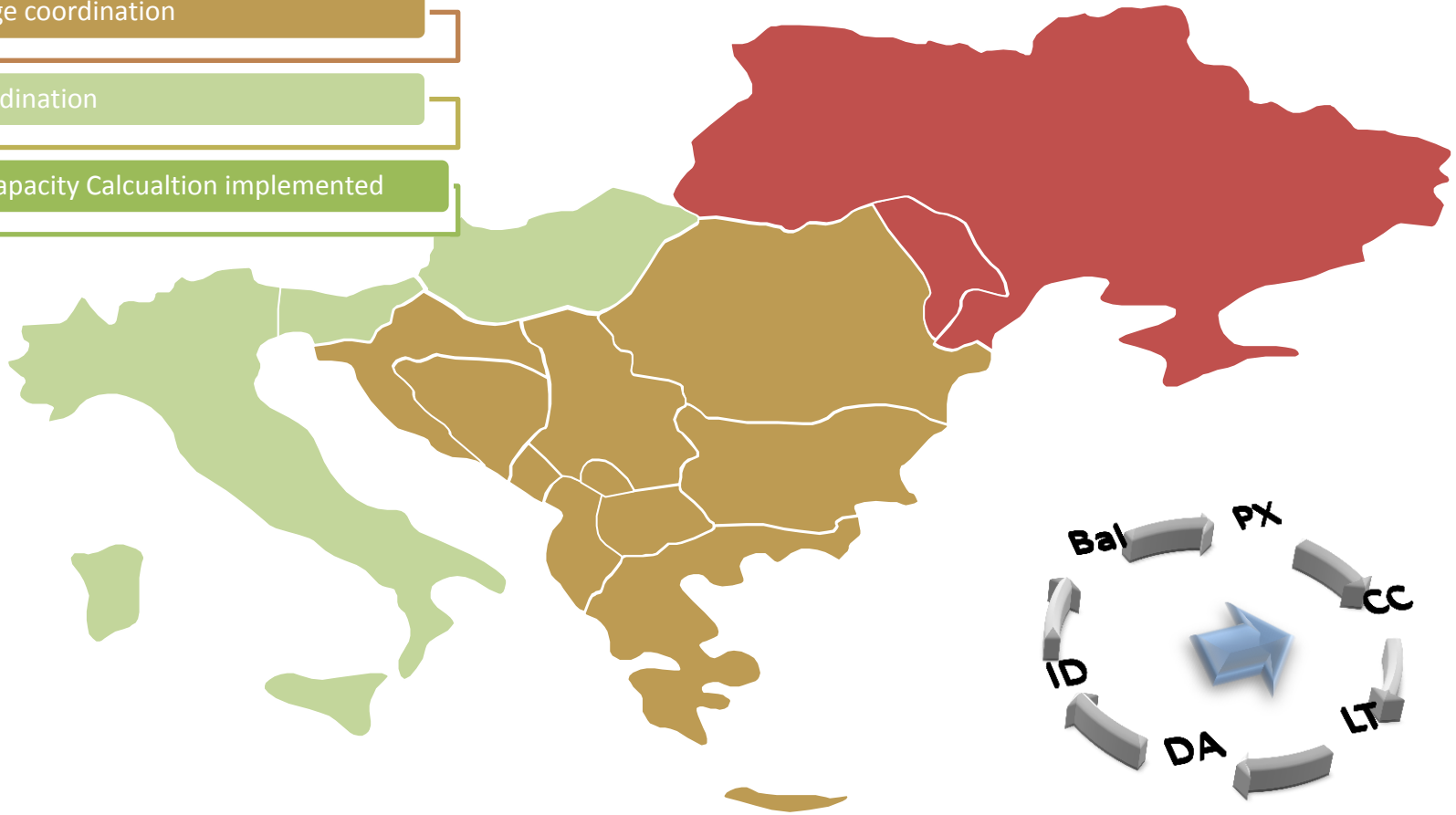

The 8th Region – Progress Maps – Long-Term Capacity Allocation

- No Coordination with 8th region neighbours
- Coordination in other Regional Initiative(s)
- Joint bilateral auctions introduced
- LT Coordinated Capacity Allocation

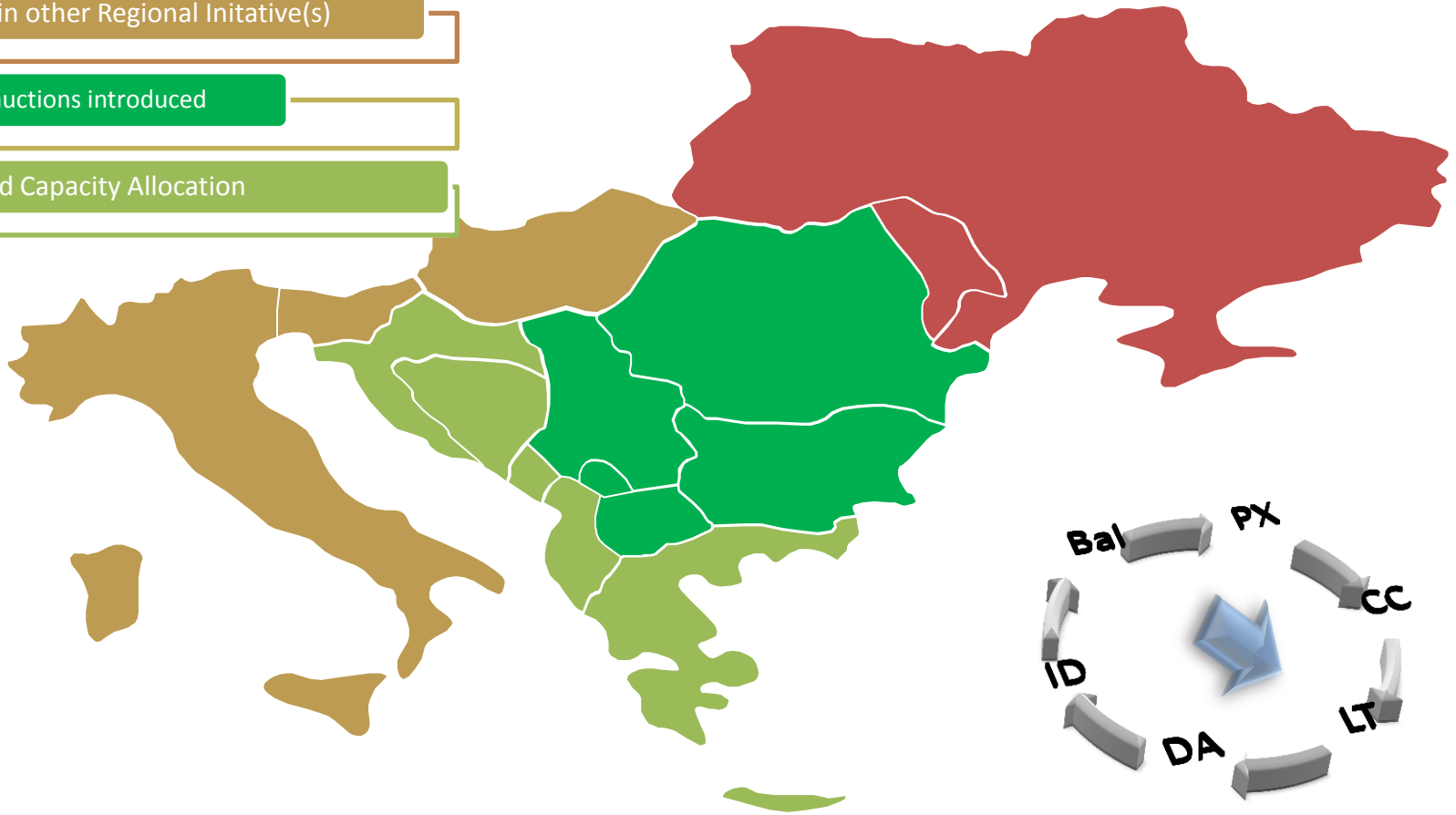

The 8th Region – Progress Maps – Day-Ahead Market Development

- No Day-Ahead Products (energy & capacity)
- DA capacity is allocated on some/all borders (ATC)
- Organised DA market exists
- Market Coupling implemented on some borders

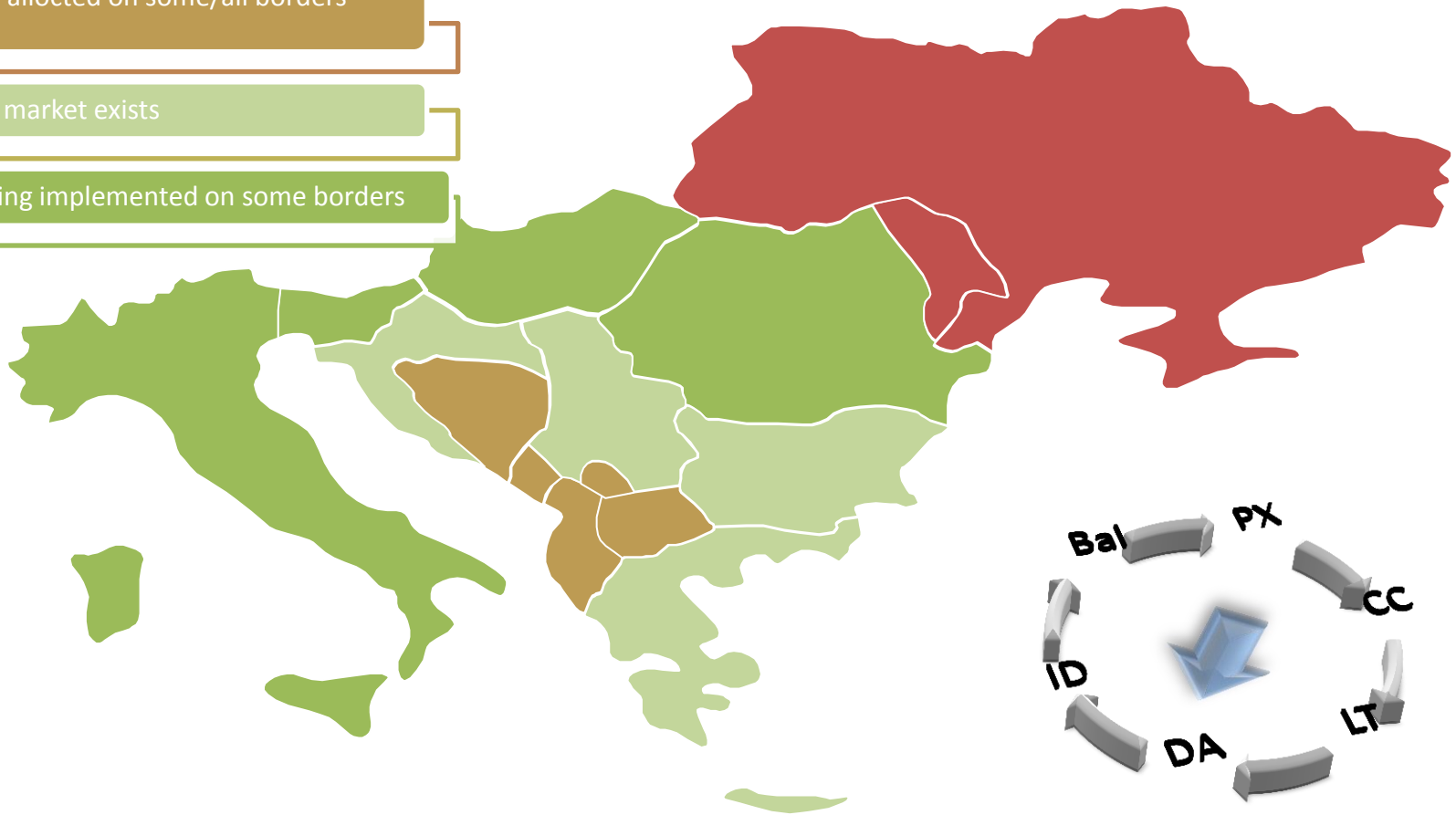

The 8th Region – Progress Maps - Intraday

No Intraday Capacity Allocation

FCFS ID Allocation / ID only on some borders

Coordinated ID Allocation on all borders

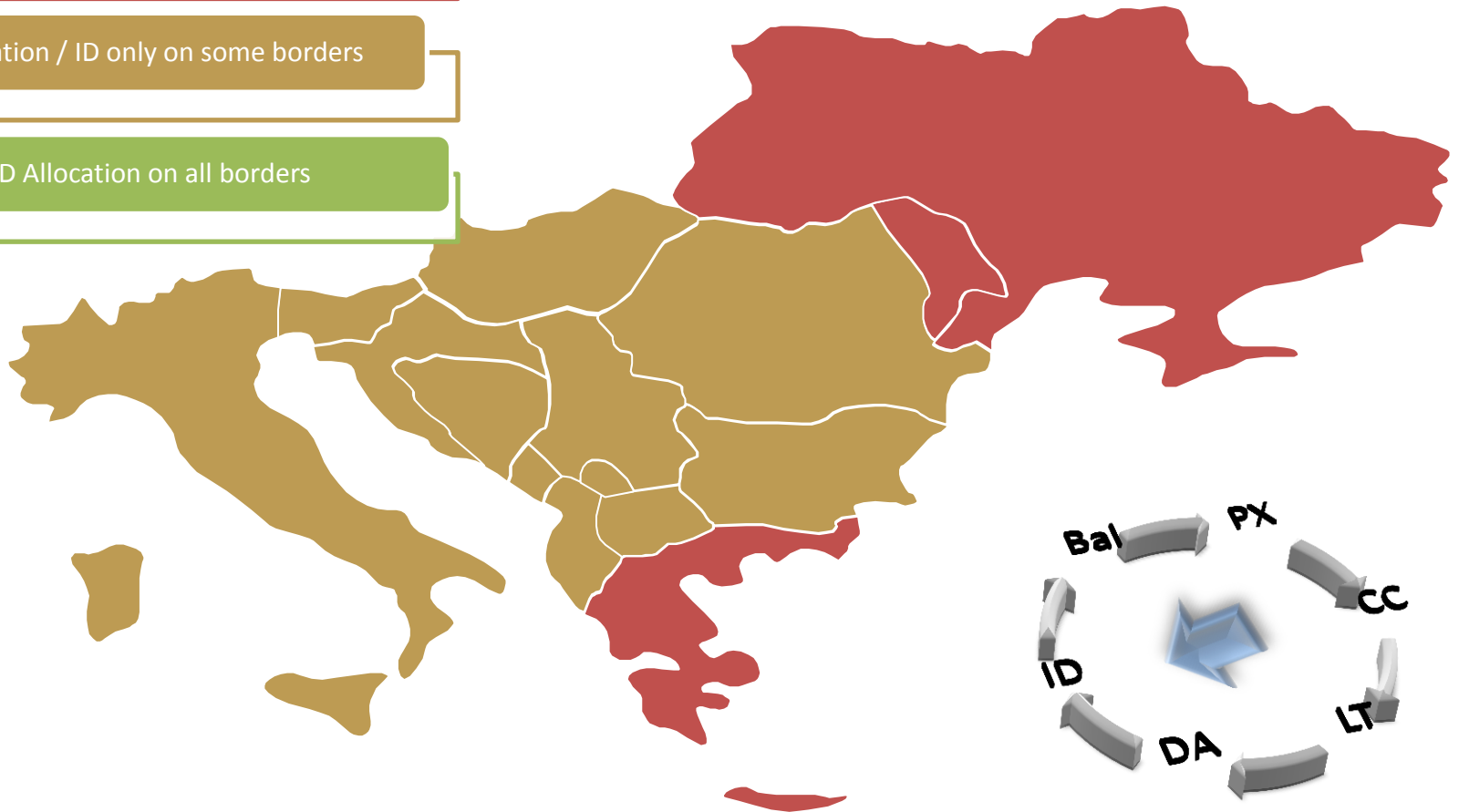

The 8th Region – Progress Maps - Balancing

No Comprehensive Imbalance Responsibility, nor Balancing Market Established

Imbalance Responsibility established

Internal Balancing Market established

Coordinated cross-border balancing market & harmonised balancing requirements established

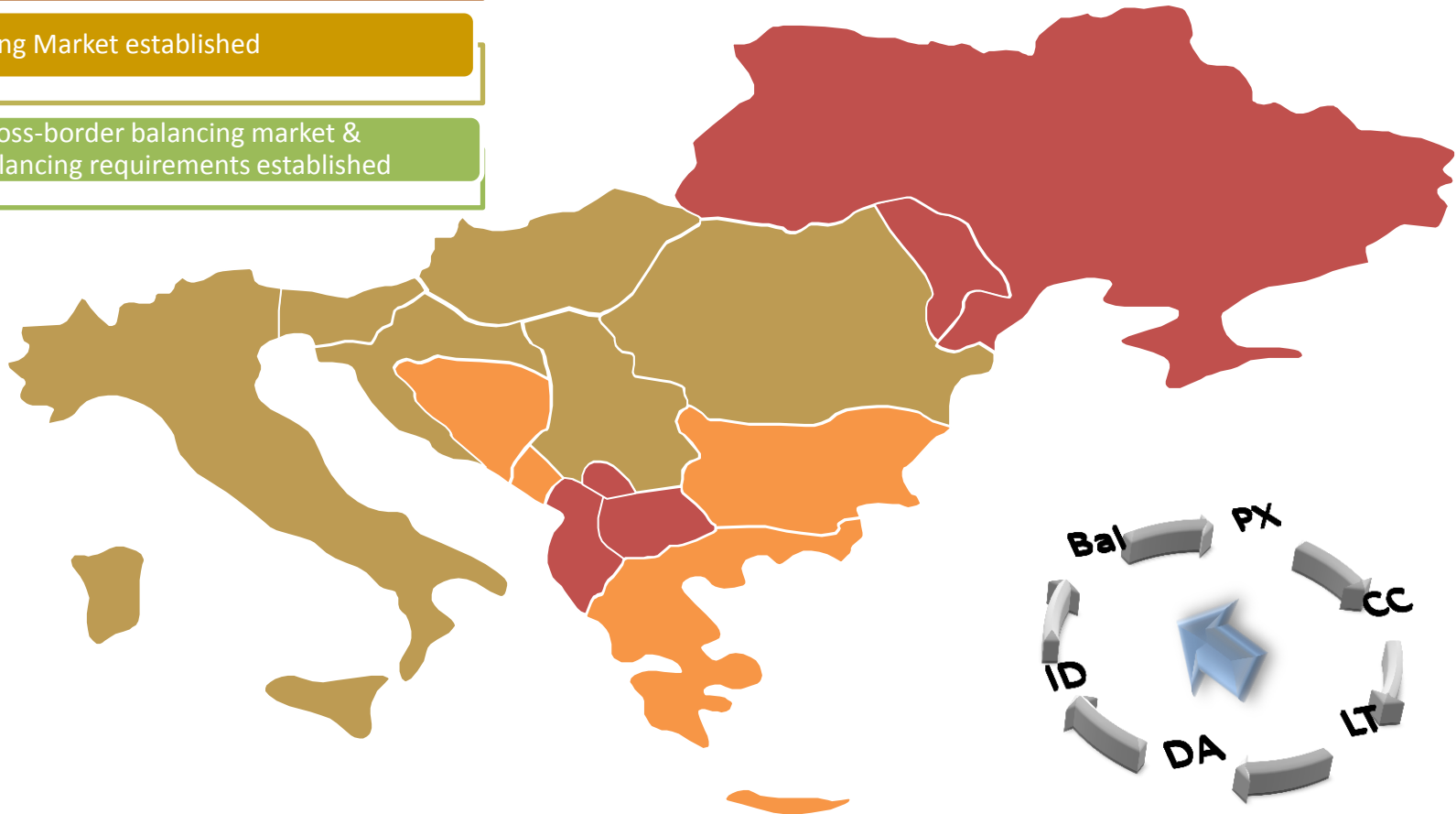

Approval process in CACM Regulation

- **TSOs and NEMOs** shall develop the **Terms and Conditions or Methodologies** required by this Regulation and **submit** them **for approval** to the competent **regulatory authorities** within the respective deadlines set out in this Regulation
- Where a proposal for Terms and Conditions or Methodologies pursuant to this Regulation needs to be developed and agreed by more than one TSO or NEMO, the participating **TSOs and NEMOs shall closely cooperate**
- TSOs, with the assistance of ENTSO-E for Electricity, and all NEMOs, shall regularly **inform the competent regulatory authorities** and the Agency **about the progress** of developing these terms and conditions or methodologies

All NRAs approval process

- **Creation of an Energy Regulators' Forum (ERF) supported by an All NRAs Working Group (John Mogg's proposal)**
- **ERF scope:**
 - a) Approve a proposal**
 - b) Request an amendment to a proposal**
 - c) Request from ACER an extension to the deadline for decision by the NRAs**
 - d) Request ACER to adopt a decision**

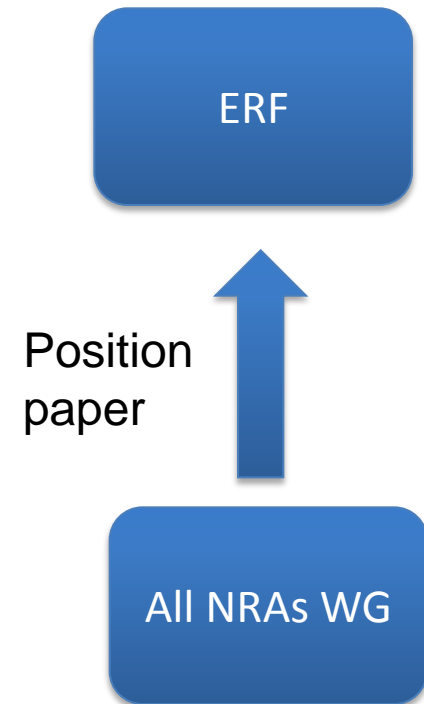

NEMO designation

- **By 15 December 2015 the following 18 PXs have been designated as NEMOs:**

APX	IBEX
Belpex	Lagie
BSP	Nord Pool
CROPEX	OKTE
EirGrid	OMIE
EPEX Spot	OPCOM
EXAA	OTE
GME	SONI
HUPX	Towarowa Gielda Energii

- **9 out of 26 MS chose monopoly, the remaining 17 chose competitive regime**
- **In 21 MS the designating authority was the NRA**

Capacity Calculation Regions

- As of 14 November 2015 all NRAs approval process on CCR proposal started
- **11 Capacity Calculation Regions:** Nordic, Hansa, CWE, Italy North, GRIT, CEE, SWE, IU, Channel, Baltic and **SEE**
- **The 11th Region (SEE)** will include borders from: **Greece, Bulgaria, Romania, Croatia, Hungary, Serbia, Bosnia-Herzegovina, Montenegro, FYR of Macedonia** and **Italy** (when the submarine connection with Montenegro will be operational)
- Possible request for amendment from NRAs: CWE-CEE merge from the beginning
- Pending issue: following ACER opinion 9/2015 TSOs the AT-DE border has been included in CEE Region. E-Control (AT) asks that reference not to be made to ACER opinion while ERU (CZ) asks to take it into account
- CACM is drafting a position paper

Bidding zone review

- August 2012: **ACER invited ENTSO-E to initiate the Bidding Zone review process** in the regions CWE, Denmark-West, CEE, Switzerland and Italy
- May 2014: ACER requested ENTSO-E to be involved in the definition of bidding zone configurations, methodologies and assumptions
- **ENTSO-E proposed 3 expert based bidding zone configurations and one model based configuration**
- September 2015 : ACER requested ENTSO-E to **extend the set of bidding zone configuration** including DE-AT splitting, DE and FR splitting in 3 zones, PL splitting in 3 zones
- **Methodologies and assumptions** have to be **consulted** with **ACER** and concerned **NRAs**
- The study will be converted into a formal CACM implementation project as of art. 34.7.

Bidding zone review

- 13 November 2015: **ENTSO-E sent a letter** to participating NRAs in order to **ask for coordinated amendments** on the bidding zone configurations, the **methodology** and the **assumptions**
- 2 February 2016: **ACER coordinates the response**, drafting a letter with two annexes
- **Main changes required:**
 - Additional expert based configuration (splitting of Germany and Austria, splitting of Germany in at least three bidding zones, splitting of France in at least three bidding zones and splitting of Poland in at least two bidding zones)
 - Two more model based configurations (small and large bidding zones)
 - Nodal configuration
 - Evaluation of benefits stemming from each single change (split or merge)

MCO functions plan

- **According to CACM (art. 7)** all NEMOs shall submit to all NRAs and the Agency a plan that sets out how to jointly set up and perform MCO functions both for the intraday and the day-ahead market time-frames.
- 29 January 2016: **first meeting of the NEMO Coordination Group** (NEMOs and NRAs)
- Proposal delivery date: 14 April 2016
- Open issues:
 - **Coordination between NEMOs and governance** (creation of all NEMO Committee, adherence to a Cooperation Agreement, allocation of voting rights)
 - **Arrangements between NEMOs and third parties** (should contracts be approved by all NRAs?)
 - **Cost assessment** (joint methodology? Who makes the assessment?), **cost sharing** (between TSOs and NEMOs, among NEMOs) and **cost recovering** (national process: harmonization required? TSO contribution: where and why?)
- CACM WS is drafting a position paper

DA/ID project

DA project

- According to CACM (art. 37) **all NEMOs** shall **submit the proposal** for the **algorithm** to NRAs for approval by no later than 18 months after the entry into force
- At the MRC IG meeting in June, NRAs asked PXs to make an assessment on the algorithm performance
- **Main issues:** paradoxically rejected bids and length of the calculation process

ID project

- 2 February 2016 ID-IG meeting
- Main issues:
 - Discussion on **accession** to NEW+ XBID project (full member, observer and accession stream)
 - NWE TSOs raised concerns that possible **requests** from **new comers** can **delay** the process (delivery date end 2017)
 - Concerns about the effectiveness of Realistic Test Scenarios (RTS) because of the unpredictable impact of automated trading on algorithm performance

Possible impacts on CPs (1)

- CACM entry into force in CPs will determine a **shift** from a **voluntary approach** to **market integration to a binding process**
- CP-TSOs shall **adopt the same Terms and Methodologies of EU-TSOs** (common grid model, capacity calculation...)
- When **CPs** will **join EU market coupling** (DA and ID) they will be called to **share the costs** according to CACM sharing keys and the MCO plan
- The **SEE Regional Action Plan** needs to be **coherent** with the **new framework...**

Possible impacts on CPs (2)

- EWG agreed to **reshape SEE RAP** with more focus to the **early implementation of the CACM in the EnC CPs** and the entire SEE region, thus providing **regulatory and TSOs expert input** on the SEE RAP details, what could be **useful input to the WB6 process** later
- As regards the situation of **not** having CACM **incorporated** into the **EnC acquis**, EWG expresses its **concerns** whether this constitutes **discrimination** in the context of **NEMO governance**, resulting in **slowing down** the Pan-European market integration, especially in the 8th CM Region (11th CCR)
- Existing possibilities, like **shadow solutions** for EnC CPs, as applied in the CCR process, may constitute an **intermediary solution** to this

Development of cross-border balancing

- During a Joint ENTSO-E & EnC WS on 3rd Package Network Codes, held in Vienna on 4 November 2013, representatives of ECRB EWG, ENTSO-E RG SEE, and ECS endorsed the launching of an Initiative aiming to develop a **Regional Balancing Concept for the 8th Region**
- In the beginning of 2014, ToR of this project were under discussion
- Project was taking place during 2014 btw SEE TSO/MOs, and NRAs joined discussions during 2015
- The “negative” opinion of ACER on the Electricity Balancing Network Code could cause delay in defining the projects work packages that should be based on the Code’s requirements
- In **January 2014**, 3 TSOs of the **SHB Control Block**, ELES, HOPS and NOS BiH, concluded an agreement on the **common procurement of balancing reserves**
- This announced cooperation aims at **reducing the overall amounts of procured balancing capacity** and it constitutes a good starting point for further initiatives that widen and deepen this cooperation
- 3 TSOs of the **SMM Control Block**, CEGES, EMS and MEPSO concluded an agreement regarding the **common procurement and sharing of balancing reserves** in 2015
- Joint NRA-TSO/MO meeting was held in order to discuss the regulatory framework in relation to imbalance settlement

Transparency

- In order to increase Market Transparency **most of SEE TSOs** are participating in the **ENTSO-E Transparency** web platform - **EMFIP**
- Although, the quality of the SEE TSOs websites has increased, **none of the CPs TSOs is in full compliance** with the legal transparency obligations
- **Regulation 543/2013** was adopted by PHLG and inserted into the Energy Community acquis, with an implementation date 18 months later
- ECRB EWG is regularly issuing a **yearly report** on the **status quo** of the **compliance** with the present **publication requirements**
- The **scope of data collection** should be the **entire 8th region**, including both the EU MS and the non EU MS
- NRAs of **Turkey** and **Georgia** are invited to **join** and analyse the requirements for contributing in the exercise

SEE Market Monitoring

Two work-streams on Electricity Market Monitoring:

1) **Market Monitoring Project** with USAID/PE support is performed regarding evaluation of the **maximum Available NTC** to the market: MM Indicators as BCE, TRM, Critical Facilities at SEEAMMS web platform

2) **Market Monitoring Report / ACER**: List of input data was defined in order to start the same MM approach in the EnC CPs

- **Discussing with ACER** about including EnC CPs MM data within **establishing a database for ACER Market Monitoring purpose** – MoU between ECRB and ACER

Note: CPs of EnC are not taking part in REMIT yet!

USAID Market Monitoring Project in SEE Region

- USAID/PE presented its proposal for MM indicators within MM general work-stream:
 - **Seven Market Monitoring Indicators** to accomplish the objectives for monitoring Cross-Border transmission capacity market
 - Market Monitoring **proposal** was **agreed and supported by ECRB EWG**, based on the Consultant (Potomac Economic) Screens proposal
 - **MM Dry-Run** has started successfully with Indicator 1 in **November 2009** as part of Transitional phase
 - **Data collected by NRAs from TSOs**
- Since 2010, under the ECRB EWG, MM Project developed:
 - **Market Monitoring Guidelines**
 - **SEE Automated Market Monitoring System (SEEAMMS)**, web address: *www.seeamms.com*
 - **Regional Monitoring Function** (to coordinate activities across the region)

Western Balkan 6 Initiative (WB6): Berlin process

- **Western Balkans 6 (“WB6”)** Initiative identifies **priority regional electricity infrastructure projects** eligible for financial support, and establishing a **list of regional and national actions** related to **spot market development, regional capacity allocation** and **cross-border balancing** (so-called “soft measures”)
- The **geographic scope** of this initiative covers: Albania, Bosnia and Herzegovina, Kosovo*, FYR of Macedonia, Montenegro and Serbia
- **EU MSs are not signatories** of the WB6 Final Declaration
- **MoU** signed on 27 April 2016 by WB6 NRAs, electricity TSOs, PXs, Ministries and MOs on regional electricity market development **establishes a governance structure** for developing a **common (WB6) spot market integration program** and **(WB6) cross border balancing cooperation program**

Conference on the Western Balkans – Berlin process

- **Conference on the Western Balkans** - 28 August 2014
- Final Declaration by the Chair of the Conference on the Western Balkans

http://www.bmeia.gv.at/fileadmin/user_upload/Zentrale/Aussenpolitik/Erklaerung_Englisch.pdf

- **Conclusion 15 – the Western Balkans countries agreed that:**
 - **European energy policy** is of increasing importance
 - **Regional cooperation** within the framework of the Energy Community is an important component
 - The Western Balkans will continue to **work intensively** on **further developing** the Energy Community and on overcoming shortcomings in implementation

Western Balkans Summit Vienna 2015 - Conclusions

- **Final Declaration by the Chair of the Vienna Western Balkans Summit**
- 27 August 2015

http://www.bmeia.gv.at/fileadmin/user_upload/Zentrale/Aussenpolitik/Chairman_s_Conclusions_Western_Balkans_Summit.pdf



**WESTERN
BALKANS
SUMMIT
VIENNA 2015**

22. The Western Balkan countries have decided to establish a regional energy market by establishing power exchanges and a regional balancing market as well as making the best use of the already existing Coordinated Auction Office. The Western Balkan countries agree on the priority list of 'soft measures' in energy covering specific national issues to implement the Energy Community *acquis* and have invited the Energy Community Secretariat to take the lead to develop the regional energy market and to help implementing these 'soft measures'. The Western Balkan countries will ensure that these issues are implemented before the next Summit in France.

Western Balkans Summit Vienna 2015 – Addendum (I)

Co-financing investment projects in Western Balkans

Western Balkans Summit Addendum

http://www.bmeia.gv.at/fileadmin/user_upload/Zentrale/Aussenpolitik/Addendum_Western_Balkans_Summit.pdf



**WESTERN
BALKANS
SUMMIT**
VIENNA 2015

Connectivity Agenda:

● Co-financing of Investment Projects:

#	Reference	Beneficiary	IFI	Description / Title	Investment € million	Grant € million	Grant in %
IPA/WBIF 2015 Co-financing					538.8	144.9	27%
ENERGY PROJECTS							
1	WBIF CF 1001 ALB ENE	Albania	KfW	Albania – the former Yugoslav Republic of Macedonia Power Interconnection (I): Grid Section in Albania	70	14	20%
2	WBIF CF 1002 MKD ENE	the former Yugoslav Republic of Macedonia	EBRD	Albania – the former Yugoslav Republic of Macedonia Power Interconnection (II): Grid Section in the former Yugoslav Republic of Macedonia	49	12	24%
3	WBIF CF 1015 MNE ENE	Montenegro	KfW	Trans-Balkan Electricity Corridor (I): Grid Section in Montenegro	127	25	20%
4	WBIF CF 1003 SER ENE	Serbia	KfW	Trans-Balkan Electricity Corridor (II): Grid Section in Serbia	28	6.6	24%

Western Balkans Summit Vienna 2015 – Addendum (II)

Energy soft measures

Energy soft measures – towards development of regional market:

- **Regional measures**
- **National measures**

Paving the way to Paris 2016...



Regional measures towards the development of a regional market

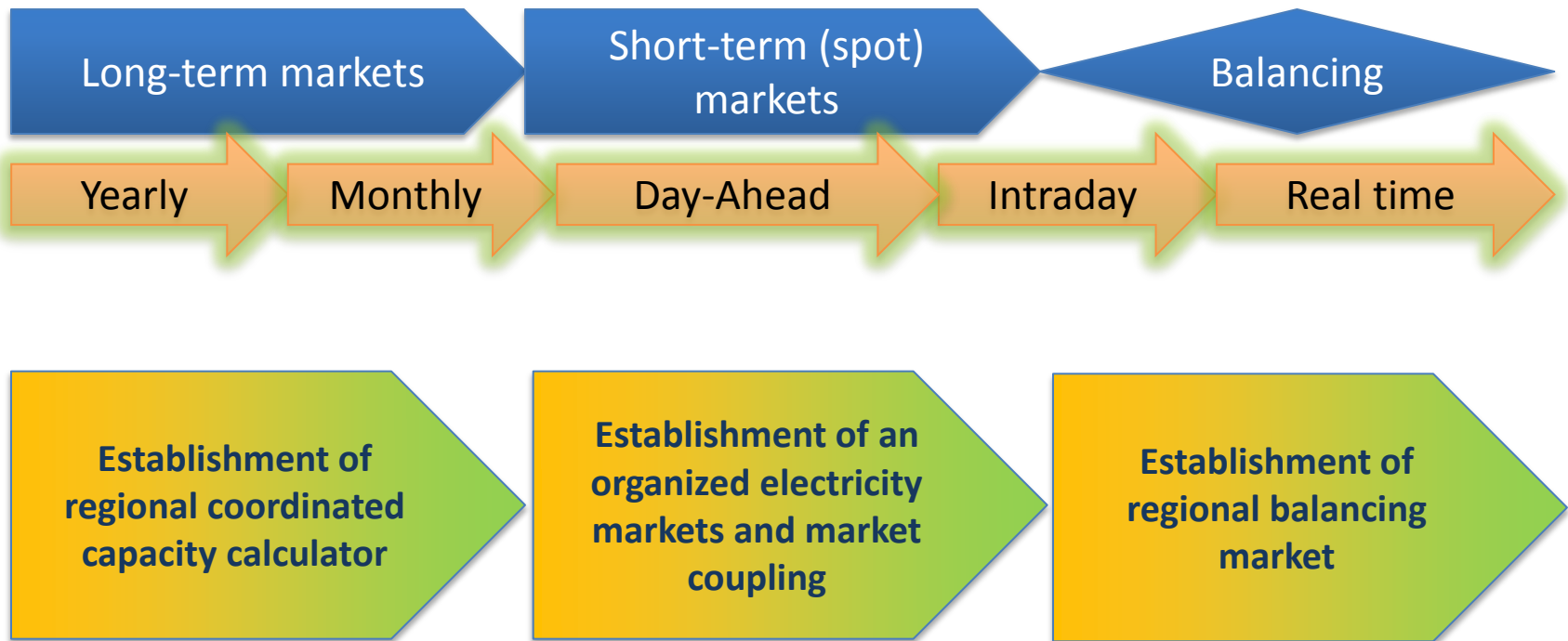

National accompanying measures

Removal of legal and regulatory obstacles

Regional Capacity Allocation



Spot Market Development

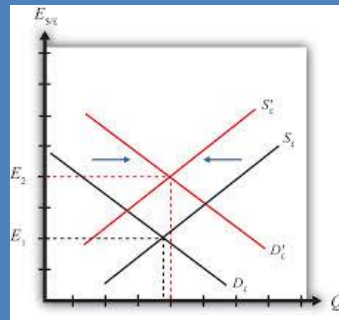

Cross-border Balancing

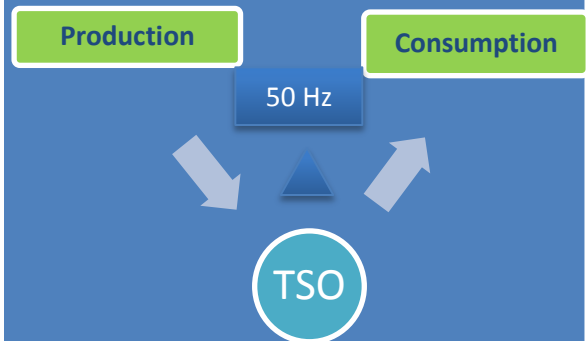

Cross-cutting measures

- Eliminating price regulation
- Granting eligibility to all customers
- TSO and DSO unbundling
- Ensuring independence of national energy authorities
- Applying for observer status in ACER
- Increase effectiveness of national administrative authorities
- Timely implementation of Trans-European Network Regulation

Thank you for your attention!

Contact:

Nenad Stefanović
ECRB EWG Co-Chairman
Senior Expert for Electricity

Energy Agency of Republic of Serbia (AERS)
Terazije 5 / V
11000 Beograd-Serbia

Tel: +381 11 3037 253

Fax: +381 11 3225 780

E-mail: nenad.stefanovic@aers.rs

URL: www.aers.rs